



POLARIS®

RZR®
170

2017
*Owner's Manual
for Maintenance
and Safety*

⚠ WARNING

Read, understand, and follow all of the instructions and safety precautions in this manual and on all product labels.

Failure to follow the safety precautions could result in serious injury or death.

⚠ WARNING

The engine exhaust from this product contains chemicals known to the State of California to cause cancer, birth defects or other reproductive harm.



For videos and more information about a safe riding experience with your Polaris vehicle, scan this QR code with your smartphone.

Visit us at www.polaris.com



POLARIS® and RZR® are trademarks of POLARIS Industries Inc.

Copyright 2016 POLARIS Industries Inc. All information contained within this publication is based on the latest product information at the time of publication. Due to constant improvements in the design and quality of production components, some minor discrepancies may result between the actual vehicle and the information presented in this publication. Depictions and/or procedures in this publication are intended for reference use only. No liability can be accepted for omissions or inaccuracies. Any reprinting or reuse of the depictions and/or procedures contained within, whether whole or in part, is expressly prohibited.

The original instructions for this vehicle are in English. Other languages are provided as translations of the original instructions.

Printed in Taiwan

2017 RZR 170 Owner's Manual

P/N 9927394

WELCOME

Dear Parents:

We believe your children should have the opportunity to enjoy the POLARIS riding experience along with you. We encourage you to teach your children to ride safely, and to help ensure the future of recreational sports, please teach them to show respect for our environment and for the rights of others while operating the vehicle.

This vehicle is not a toy and can be hazardous to operate. We've provided this owner's manual and an instructional video to help you and your children learn about the safe operation and care of your new POLARIS vehicle. Before your children drive or ride in the vehicle, please read and make sure they read this owner's manual. Watch the instructional video with them. *Make sure all operators and passengers understand and follow all of the instructions and warnings contained in this owner's manual and video.* Make sure they understand that the vehicle must be used under adult supervision at all times.

After reading this owner's manual and watching the video, help your child practice the New Operator Driving Procedures on pages 42-43.

Never allow a child under age 10 to operate or ride as a passenger in this vehicle. Children differ in skills, physical abilities and judgement. Please supervise the use of the vehicle at all times. Permit continued use only if you determine that your child has the ability and maturity to operate safely.

For your child's safety, be sure your child can reach and operate all RZR 170 controls, including steering wheel, accelerator and brake pedals, and ignition switch. Make sure your child is not too tall to ride safely in this vehicle. See page 12.

The vehicle's speed control system allows adults to limit vehicle speed for new and inexperienced operators. Please see page 35 for more information.

The preventive maintenance program outlined in this manual is designed to ensure that all critical components on your child's vehicle are thoroughly inspected at specific intervals. Always follow all of the instructions and recommendations in this manual to ensure the vehicle remains in safe operating condition at all times.

This POLARIS vehicle is not designed for adult use. Serious damage may occur if the maximum weight capacity is exceeded. Refer to vehicle labels and to the specifications section beginning on page 92 for the maximum weight capacity.

WELCOME

Dear Young Operators:

Before you ride your new POLARIS vehicle, there are some important things that you need to know. You must learn how to keep yourself and those around you safe while you're riding.

Your parents and POLARIS want you to be safe while you enjoy riding your new vehicle, and that's why it's very important that you read this owner's manual and watch the instructional video. Make sure you *understand and follow all of the instructions and warnings in this owner's manual and video*. Ask your parents to explain anything you don't understand.

Your safety and the safety of others is the most important thing to think about at all times. Pay attention when you see this symbol:



This is the safety alert symbol. When you see this symbol on your vehicle or in this manual it means **PAY ATTENTION** because you could die or be seriously injured if you don't follow the instructions.

After reading this owner's manual and watching the video, complete the New Operator Driving Procedures on pages 42-43. Show your parent that you understand how to drive safely.

Enjoy riding your new POLARIS vehicle!

TABLE OF CONTENTS

Introduction	6
Safety	9
Features and Controls	24
Operation	36
Emission Control Systems	52
Maintenance	53
Specifications	92
POLARIS Products	94
Troubleshooting	95
Warranty	99
Maintenance Log	106
Index	108

INTRODUCTION

The following signal words and symbols appear throughout this manual and on your vehicle. Your safety is involved when these words and symbols are used. Become familiar with their meanings before reading the manual.



The safety alert symbol indicates a potential personal injury hazard.

DANGER

A DANGER indicates a hazardous situation that, if not avoided, will result in death or serious injury.

WARNING

A WARNING indicates a hazardous situation that, if not avoided, could result in death or serious injury.

CAUTION

A CAUTION indicates a hazardous situation that, if not avoided, could result in minor or moderate injury.

NOTICE

A NOTICE indicates a situation that could result in property damage.



The Prohibition Safety Sign indicates an action NOT to take in order to avoid a hazard.



The Mandatory Action Sign indicates an action that NEEDS to be taken to avoid a hazard.

INTRODUCTION

WARNING

Failure to follow the warnings and safety precautions contained in this manual can result in severe injury or death. Your POLARIS vehicle is not a toy and can be hazardous to operate. This vehicle handles differently than cars, trucks or other off-road vehicles. A collision or rollover can occur quickly, even during routine maneuvers like turning, or driving on hills or over obstacles, if you fail to take proper precautions.

- Never operate this vehicle without proper instruction. All operators and supervising adults must watch the instructional video that was provided with the vehicle. Read this owner's manual and review the safety DVD that came with your vehicle. A free extra copy of the DVD can be obtained by contacting your local POLARIS dealer. Understand all safety warnings, precautions and operating procedures before operating the vehicle. Keep this manual with the vehicle.
- For your child's safety, be sure your child can reach and operate all RZR 170 controls, including steering wheel, accelerator and brake pedals, and ignition switch. No person under the age of 10 may ride as a passenger in this vehicle. All riders must be able to sit with backs against the seat, both feet flat on the floor and both hands on the steering wheel (if driving) or on a passenger hand hold.
- Always follow the age guidelines for your vehicle. Operation is prohibited for anyone under age 10. Never operate with a passenger under age 10.
- Always use the cab nets (or doors) while riding in this vehicle. Always keep hands, feet and all other body parts inside the vehicle at all times.
- Always wear a helmet, eye protection, gloves, long-sleeve shirt, long pants and over-the-ankle boots.
- Complete the New Operator Driving Procedures outlined on pages 42-43. Never allow a guest to operate this vehicle until the guest has watched the instructional video and has completed the New Operator Driving Procedures.

INTRODUCTION

Vehicle Identification Numbers

Record your vehicle's identification numbers and key number in the spaces provided. Remove the spare key and store it in a safe place. An ignition key can be duplicated only by ordering a POLARIS key blank (using your key number) and mating it with one of your existing keys. The ignition switch must be replaced if all keys are lost.

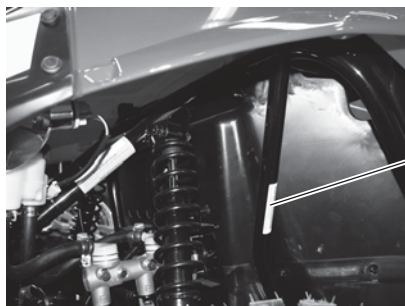

Vehicle Identification Number
(left front wheel well)

Engine Serial Number
(left rear wheel well)

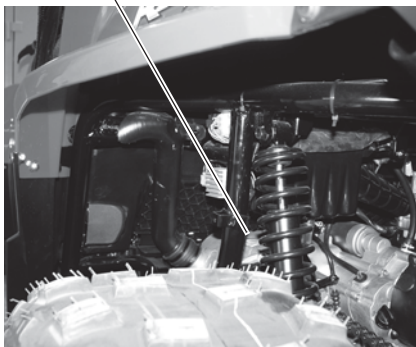
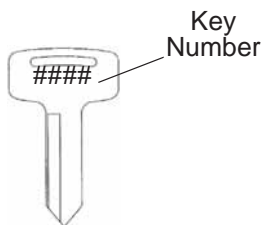

Vehicle Model Number: _____

Vehicle Identification Number: _____

Engine Serial Number: _____

Key Number _____

Equipment Modifications

Your POLARIS vehicle is designed to provide safe operation when used as directed.

WARNING! Modifying this vehicle in any way can change the top speed, stability and handling performance of this vehicle. Modifications that increase speed, decrease stability or change performance may present a greater risk to inexperienced or younger operators and could result in loss of control and serious injury or death. Use only POLARIS-approved accessories to modify this vehicle. Review all vehicle changes with your child prior to operating.

The POLARIS limited warranty on your POLARIS vehicle will be terminated if any non-POLARIS-approved equipment and/or modifications have been added to the vehicle that increase speed or power.

European Vibration and Noise

The driver-perceived noise and hand/arm and whole body vibration levels of this machinery is measured per prEN 15997.

The operating conditions of the machinery during testing:

The vehicles were in like-new condition. The environment was controlled as indicated by the test procedure(s).

The uncertainty of vibration exposure measurement is dependent on many factors, including:

- Instrument and calibration uncertainty
- Variations in the machine such as wear of components
- Variation of machine operators such as experience or physique
- Ability of the worker to reproduce typical work during measurements
- Environmental factors such as ambient noise or temperature

SAFETY

Safe Riding Gear

The driver and passenger must wear helmet, eye protection, gloves, long-sleeve shirt, long pants, over-the-ankle boots and seat belt at all times. Protective gear reduces the chance of injury.

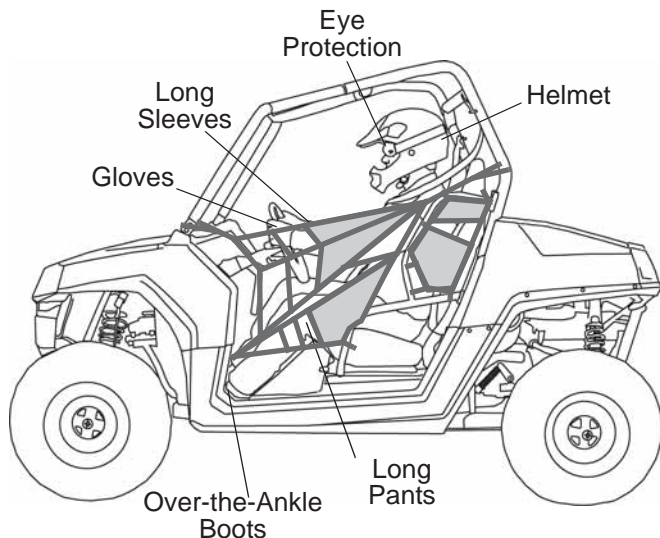

Helmet

Wearing a helmet can prevent a severe head injury. Whenever riding this POLARIS vehicle, always wear a helmet that meets or exceeds established safety standards.

Approved helmets in the USA and Canada bear a U.S. Department of Transportation (DOT) label.

Approved helmets in Europe, Asia and Oceania bear the ECE 22.05 label. The ECE mark consists of a circle surrounding the letter E, followed by the distinguishing number of the country which has granted approval. The approval number and serial number will also be displayed on the label.

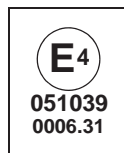

Safe Riding Gear

Eye Protection

Do not depend on eyeglasses or sunglasses for eye protection. Whenever riding this POLARIS vehicle, always wear shatterproof goggles or use a shatterproof helmet face shield. POLARIS recommends wearing approved Personal Protective Equipment (PPE) bearing markings such as VESC 8, V-8, Z87.1, or CE. Make sure protective eye wear is kept clean.

Gloves

Wear gloves for comfort and for protection from sun, cold weather and other elements.

Boots

Wear sturdy over-the-ankle boots for support and protection. Never ride a POLARIS vehicle with bare feet or sandals.

Clothing

Wear long sleeves and long pants to protect arms and legs.

Rider Comfort

Under certain operating conditions, heat generated by the engine and exhaust system can elevate temperatures in the driver and passenger cab area. The condition occurs most frequently when a vehicle is being operated in high ambient temperatures at low speeds and/or high load conditions for an extended period of time. The use of certain windshield, roof and/or cab systems may contribute to this condition by restricting airflow. Any discomfort due to heat buildup in this area can be minimized by wearing proper riding apparel and by varying speeds to increase airflow.

SAFETY

Safety Warnings

⚠ WARNING

Failure to operate this vehicle properly can result in a collision, loss of control, accident or rollover, which may result in serious injury or death. Heed all safety warnings outlined in this section of the owner's manual and in the safety DVD provided with your vehicle.

Be sure to read all of the following warnings about driving hazards and how to avoid them. These warnings are provided for your child's safety. Be sure to explain to your young driver that the hazards outlined in this section of this owner's manual **MUST** be avoided at all times. See the OPERATION section of this owner's manual for proper operating procedures.

Operating Without Instruction

Operating this vehicle without proper instruction increases the risk of an accident. The operator and the supervising adult must understand how to operate the vehicle properly in different situations and on different types of terrain. Complete the New Operator Driving Procedures outlined on pages 42-43.

All operators must read and understand this owner's manual and all warning and instruction labels before operating the vehicle. Never allow a guest to operate this vehicle until the guest has read this manual and all product labels and has completed the New Operator Driving Procedures outlined on pages 42-43.

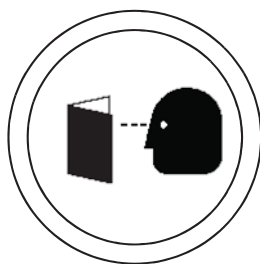

Age Restrictions

This vehicle is for recreational use by young operators under adult supervision **ONLY**.

Operation is prohibited for anyone under age 10. Never operate with a passenger under age 10. All riders must be able to sit with backs against the seat, both feet flat on the floor and both hands on the steering wheel (if driving) or on a passenger hand hold.



Rider Height

Some riders may be too tall to ride safely in this vehicle. Do not operate or ride in this vehicle if the clearance between the top of your helmet and the overhead cab frame is less than 2 inches (5 cm).

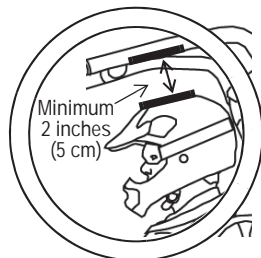

Safety Warnings

Failure to Inspect Before Operating

Failure to inspect and verify that the vehicle is in safe operating condition before operating increases the risk of an accident.

Always inspect the vehicle before each use to make sure it's in safe operating condition. See page 38.

Always follow the inspection and maintenance procedures and schedules described in this owner's manual. See page 53.

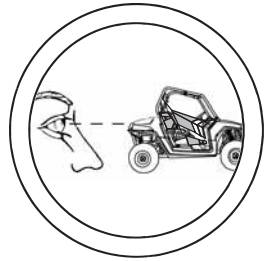

Protective Apparel

Riding in this vehicle without wearing an approved helmet and protective eyewear increases the risk of serious injury in the event of an accident.

Operator and passenger must always wear an approved helmet that fits properly and eye protection (goggles or face shield).



Seat Belts

Riding in this vehicle without wearing the seat belt increases the risk of serious injury in the event of rollover, loss of control, other accident or sudden stop. Seat belts may reduce the severity of injury in these circumstances. Riders *must* wear seat belts at all times. Always make sure the seat belts are secured for both the operator and passenger before riding.

Cab Nets

Riding in this vehicle without using the cab nets (or doors, if equipped) increases the risk of serious injury or death in the event of an accident or rollover. Always use the cab nets (or doors) while riding in this vehicle. *Always keep hands and feet inside the vehicle at all times.*

SAFETY

Safety Warnings

Using Alcohol or Drugs

Riding in this vehicle after consuming alcohol or drugs could adversely affect operator judgment, reaction time, balance and perception.

Never consume alcohol or drugs before or while operating or riding in this vehicle.



Carrying a Passenger

Never carry a passenger until you have operated this vehicle for at least four hours and have completed the New Operator Driving Procedures outlined on pages 42-43.

Carrying Multiple Passengers

A passenger must always be seated in a passenger seat with seat belt secured. Carrying more than one passenger in this vehicle can affect the operator's ability to steer and operate the controls, which increases the risk of loss of control and accident or rollover. Never carry more than one passenger in this vehicle.



Operating on Pavement

This vehicle's tires are designed for off-road use only, not for use on pavement. Operating this vehicle on paved surfaces (including sidewalks, paths, parking lots and driveways) may adversely affect the handling of the vehicle and may increase the risk of loss of control and accident or rollover. Avoid operating the vehicle on pavement. If it's unavoidable, travel slowly, travel short distances and avoid sudden turns or stops.

Operating on Public Roads

Operating this vehicle on public streets, roads or highways could result in a collision with another vehicle. Never operate this vehicle on any public street, road or highway, including dirt and gravel roads (unless designated for off-highway use).



Safety Warnings

Operating at Excessive Speeds

Operating this vehicle at excessive speeds increases the operator's risk of losing control.

Always operate at a speed that's appropriate for the terrain, the visibility and operating conditions, your skills and experience and your passengers' skills and experience.



Turning Improperly

Turning improperly could cause loss of traction, loss of control, accident or rollover. Always follow proper procedures for turning as described in this owner's manual.

Never turn abruptly or at sharp angles. Never turn at high speeds. Practice turning at slow speeds before attempting to turn at faster speeds.

Physical Control of the Vehicle

Removing hands from the steering wheel or hand holds or removing feet from the floor while riding increases the risk of loss of control and accident or rollover.

The operator should always keep both hands on the steering wheel during operation. A passenger should always be seated in the passenger seat with both feet on the floor and with both hands securely grasping the hand holds.

Always keep hands and feet inside the vehicle at all times.

Jumps and Stunts

Exhibition driving increases the risk of an accident or rollover. DO NOT do power slides, "donuts", jumps or other driving stunts. Avoid exhibition driving.

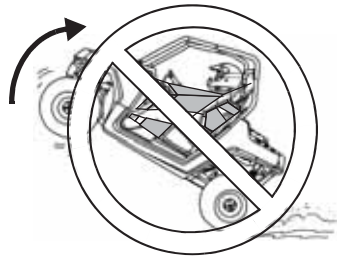

SAFETY

Safety Warnings

Driving Downhill Improperly

Driving down a hill improperly could cause loss of control or rollover. Always follow proper procedures for driving down a hill as described in this owner's manual. See page 47.

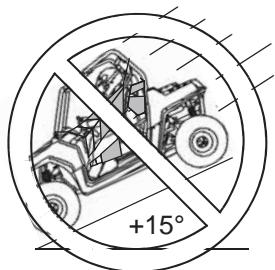

Improper Hill Climbing

Improper hill climbing could cause loss of control or rollover. Use extreme caution when operating on hills. Always follow proper procedures for hill climbing as described in this owner's manual. See page 46. Never operate the vehicle on hills steeper than 15 degrees.

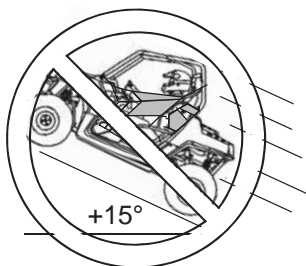

Safety Warnings

Stalling While Climbing a Hill

Stalling or rolling backwards while climbing a hill could cause a rollover. Maintain a steady speed when climbing a hill.

If you lose all forward speed:

Apply the brakes gradually until the vehicle is fully stopped. Place the transmission in reverse and slowly allow the vehicle to roll straight downhill while applying light brake pressure to control speed.

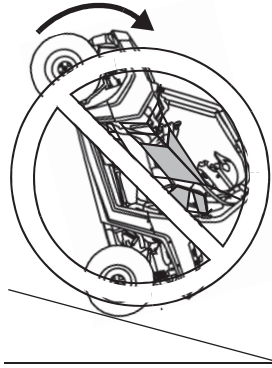

Crossing Hillside

Driving on a sidehill is not recommended. Improper procedure could cause loss of control or rollover. Avoid crossing the side of any hill unless absolutely necessary.

If crossing a hillside is unavoidable, always follow proper procedures as described in this owner's manual. See page 47.

Operating in Unfamiliar Terrain

Failure to use extra caution when operating on unfamiliar terrain could result in an accident or rollover.

Unfamiliar terrain may contain hidden rocks, bumps, or holes that could cause loss of control or rollover.

Travel slowly and use extra caution when operating on unfamiliar terrain. Always be alert to changing terrain conditions.



SAFETY

Safety Warnings

Operating on Sand or Slippery Terrain

Operating on sand or on excessively rough, slippery or loose terrain could cause loss of traction, loss of control, accident or rollover.

Always use extra caution when operating on sand or on rough, slippery or loose terrain.

Do not operate on *excessively* rough, slippery or loose terrain.



Operating Improperly in Reverse

Improperly operating in reverse could result in a collision with an obstacle or person. Always follow proper operating procedures as outlined in this manual. See page 50.

Before shifting into reverse gear, always check for obstacles or people behind the vehicle. When it's safe to proceed, back slowly.

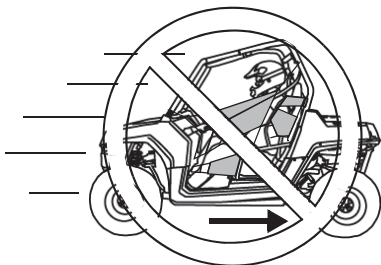

Improper Tires and Maintenance

Operating this vehicle with improper tires or with improper or uneven tire pressure could cause loss of control, accident or rollover.

Always use the size and type of tires specified for your vehicle. Always maintain proper tire pressure as described in this owner's manual and on safety labels.



Safety Warnings

Operating Over Obstacles

Improperly operating over obstacles could cause loss of control or rollover.

Before operating in a new area, check for obstacles. Never attempt to operate over large obstacles such as large rocks or fallen trees. Always follow the proper procedures outlined in this manual when operating over obstacles. See page 49.



Operating Through Water

Operating through deep or fast-flowing water can cause loss of traction, loss of control, rollover or accident. Never operate in fast-flowing water or in water that exceeds the floor level.

Always follow proper procedures for operating in water as described in this owner's manual. See page 48.

Wet brakes may have reduced stopping ability. After leaving water, test the brakes. Apply them lightly several times while driving slowly. The friction will help dry out the pads.



SAFETY

Safety Warnings

Overloading the Vehicle

Overloading the vehicle or carrying/towing loads may cause changes in stability and handling, which could cause loss of control or an accident.

- Never tow objects or carry loads with this vehicle.
- Never exceed the maximum weight capacity for this vehicle. See page 23.

Operating a Damaged Vehicle

Operating a damaged vehicle can result in an accident. After any rollover or other accident, have a qualified service dealer inspect the entire machine for possible damage, including (but not limited to) seat belts, rollover protection devices, brakes, throttle and steering systems.

Operating on Frozen Bodies of Water

Operating on frozen bodies of water can result in the vehicle and/or riders falling through the ice. Never operate this vehicle on a frozen body of water.

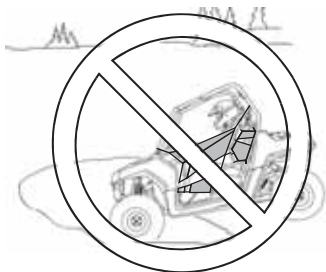

Safety Warnings

Refueling

Gasoline is highly flammable and is explosive under certain conditions. Always exercise extreme caution whenever handling gasoline.

- Never allow a child to refuel or handle gasoline.
- Always stop the engine when refueling.
- Always refuel outdoors or in a well ventilated area.
- Do not smoke or allow open flames or sparks in or near the refueling area or where gasoline is stored.
- Never refuel while a person is in the vehicle.
- Do not over fill the tank. Do not fill the tank neck.
- If gasoline spills on your skin or clothing, immediately wash it off with soap and water and change clothing.

Exposure to Exhaust

Engine exhaust fumes are poisonous and can cause loss of consciousness or death in a short time. Never start the engine or let it run in an enclosed area.

Operate this vehicle only outdoors or in well-ventilated areas.

Hot Exhaust Systems

Exhaust system components are very hot during and after use of the vehicle. Hot components can cause burns and fire. Do not touch hot exhaust system components. Always keep combustible materials away from the exhaust system.

Use caution when traveling through tall grass, especially dry grass. Always inspect the underside of the vehicle and areas near the exhaust system after driving through tall grass, weeds, brush and other tall ground cover. Promptly remove any grass or debris clinging to the vehicle.

Unauthorized Use of the Vehicle

Leaving the keys in the ignition can lead to unauthorized use of the vehicle by someone under the age of 10 or without proper training. This could result in an accident or rollover. Always remove the ignition key when the vehicle is not in use.

**FOR MORE INFORMATION ABOUT SAFETY
call POLARIS at 1-800-342-3764.**

SAFETY

Safety Labels and Locations

Warning labels have been placed on the vehicle for your protection. Read and follow the instructions on each label carefully. If any of the labels shown in this manual differ from the labels on your vehicle, always read and follow the instructions of the labels on the *vehicle*.

If an informational or graphic label becomes illegible or comes off, contact your POLARIS dealer to purchase a replacement. Replacement *safety* labels are provided by POLARIS at no charge. The part number is printed on the label.

Dash Warning Label



Rear Warning Label



Safety Labels and Locations

Rear Warning Label

WARNING

Improper vehicle use can result in SEVERE INJURY or DEATH

NEVER allow vehicle to be operated:

- without adult supervision.
- by anyone under age 10.
- with a passenger under age 10.
- with a passenger whose feet cannot touch the floor.
- without all occupants first viewing and understanding safety video and warning labels.
- with more than one passenger.
- on hills steeper than 15 degrees $\leq 15^\circ$.
- on paved surfaces - pavement may seriously affect handling and control.
- with non-POLARIS approved accessories - they may seriously affect stability.
- at speeds that are too fast for the operator's skills, the conditions and/or the terrain.

ALWAYS require operator and passenger to:

- wear seat belts, grab hand holds (passenger) and plant feet firmly on the floor.
- secure cab nets.
- keep hands and feet inside vehicle.
- avoid quick turns of the steering wheel and driving stunts such as jumps, donuts or power slides.
- reduce speed and use extra caution when carrying a passenger.
- watch for branches or other hazards that could enter vehicle.

WARNING

Operation of this vehicle by children under age 10 increases the risk of severe injury or death.

Adult supervision required for children under age 16.

NEVER permit children under age 10 to operate or ride in this vehicle.

WARNING

VEHICLE ROLLOVER could cause severe injury or death. The cab frame is not designed or intended to provide rollover protection.

TIRE PRESSURE IN PSI (KPa):

Front: 3 (20.7)

Rear: 3 (20.7)

MAXIMUM WEIGHT CAPACITY 300 lbs. (136 KG)

INCLUDES WEIGHT OF OPERATOR, PASSENGER AND ACCESSORIES. LOCATE AND READ OWNER'S MANUAL. FOLLOW ALL INSTRUCTIONS AND WARNINGS. IF OWNER'S MANUAL IS MISSING, CONTACT A POLARIS DEALER FOR A REPLACEMENT.



FEATURES AND CONTROLS

Component Locations

Your vehicle is equipped with cab nets on both sides of the vehicle. Cab nets must be used by both operator and passenger at all times. Promptly replace worn or damaged cab nets with new cab nets, available from your authorized POLARIS dealer. The vehicle illustrated below is shown without cab nets only to allow component identification. Always use the cab nets.

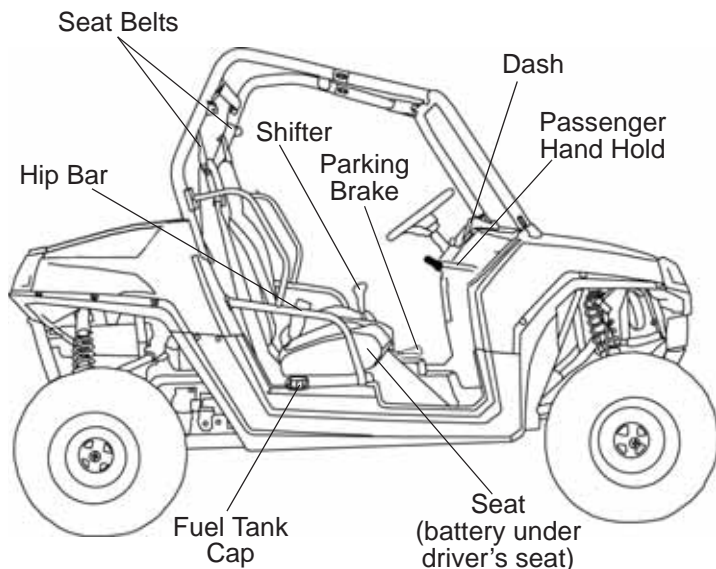

Cab Net

FEATURES AND CONTROLS

Component Locations

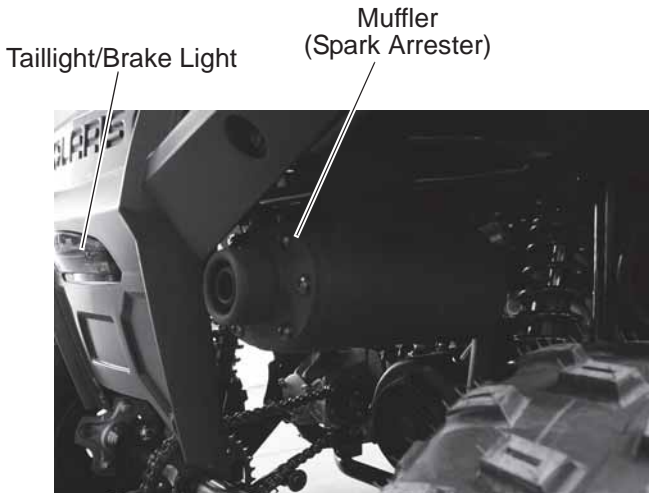
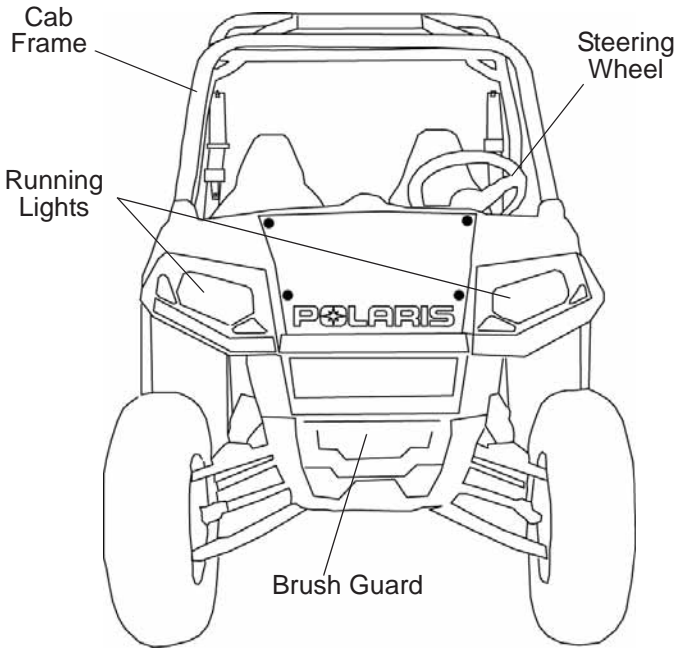

FEATURES AND CONTROLS

Seats

Driver's Seat Adjustment

1. Lift the seat latch lever located under the right front edge of the driver's seat.
2. While holding the lever upward, slide the seat forward or rearward to the desired position, then release the lever.
3. Slide the seat forward and rearward to ensure the latch is engaged. Before operating the vehicle, always make sure both seats are securely installed.

Seat Latch Lever



Seat Removal

1. To remove the driver's seat, lift the seat latch lever.
2. While holding the lever upward, slide the seat completely forward to remove it from the seat mounting rails.
3. Before operating the vehicle, always make sure the driver's seat is installed and securely latched.
4. To remove the passenger seat, remove the two bolts located at the front of the seat mounting rails. Slide the seat forward to remove it from the vehicle. *Always reinstall the passenger seat before operating the vehicle.* After reinstalling the seat and bolts, torque the nuts to 10 ft. lbs. (13.5 Nm).



←
Slide Seat Forward

FEATURES AND CONTROLS

Steering Wheel

The steering wheel can be adjusted upward or downward for rider preference.

1. Loosen the steering wheel adjustment bolt.
2. Move the steering wheel upward or downward to the desired position.
3. Tighten the bolt to 10 ft. lbs. (13.5 Nm).



Passenger Hand Hold

Always adjust the hand hold to a comfortable position for your passenger before operating. Make sure the adjustment pin and retainer are securely installed after making adjustments.

1. Remove the retainer from the end of the adjustment pin. Remove the pin from the post.
2. Slide the post inward or outward to the desired position.
3. Reinstall the pin through the mounting bracket hole, through both post adjustment holes, and through the remaining bracket hole.
4. Reinstall the retainer to the pin.

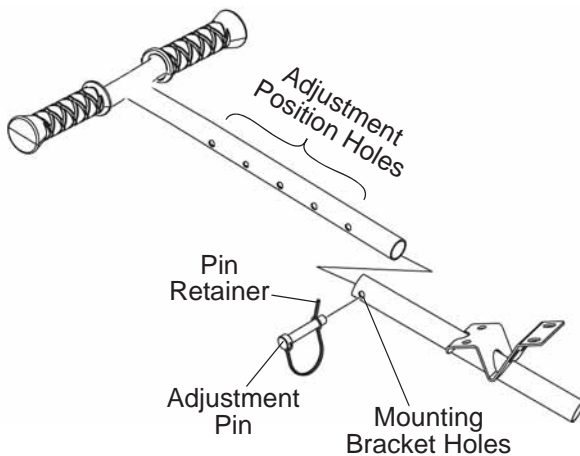

FEATURES AND CONTROLS

Seat Belts

This POLARIS vehicle is equipped with three-point lap and diagonal seat belts for the operator and passenger. Always make sure the seat belts are secured for both the operator and passenger before riding.

To wear the seat belt properly, follow this procedure:

1. Pull the seat belt latch downward and across your chest toward the buckle at the inner edge of the seat. The belt should fit snugly across your hips and diagonally across your chest. Make sure the belt is not twisted.

Tip: The position of the shoulder strap can be adjusted to the height of the operator. Have an adult relocate the mounting bolt to a different position, making sure the nut and bolt are tightened securely.

2. Push the latch plate into the buckle until it clicks.
3. Release the strap, it will self-tighten.
4. Press the red release latch on the buckle to release the seat belt.

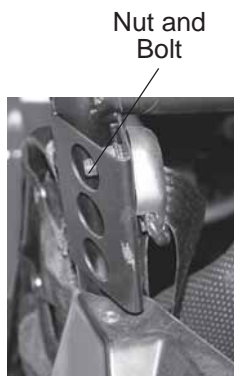
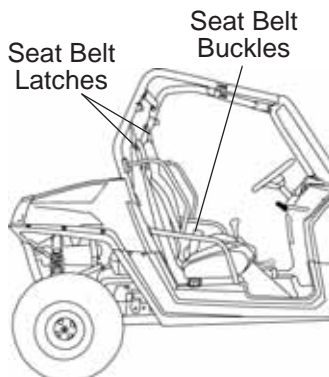

FEATURES AND CONTROLS

Seat Belts

Seat Belt Inspection

Inspect all seat belts for proper operation before each use of the vehicle.

1. Push the latch plate into the buckle until it clicks. The latch plate must slide smoothly into the buckle. A click indicates that it's securely latched.
2. Push the red release latch in the middle of the buckle to make sure it releases freely.
3. Pull each seat belt completely out and inspect the full length for any damage, including cuts, wear, fraying or stiffness. If any damage is found, or if the seat belt does not operate properly, have the seat belt system checked and/or replaced by an authorized POLARIS dealer.
4. To clean dirt or debris from the seat belts, sponge the straps with mild soap and water. Do not use bleach, dye or household detergents.

FEATURES AND CONTROLS

Cab Nets

Riding in this vehicle without using the cab nets increases the risk of serious injury or death in the event of an accident or rollover.

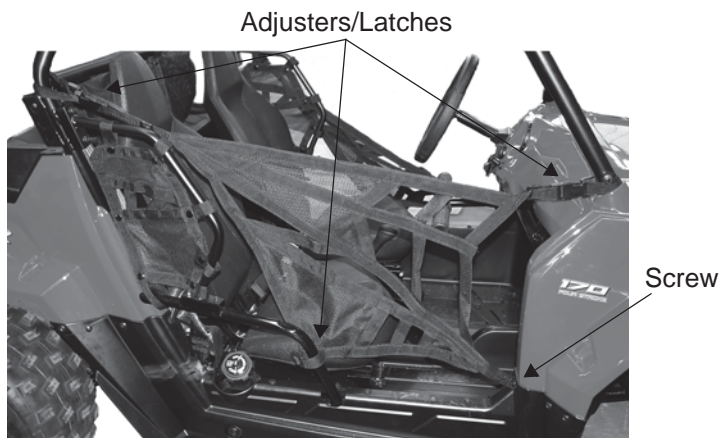

Cab nets must be used by both operator and passenger at all times. Make sure all latches are secure before operating the vehicle.

Always inspect cab nets for tightness, wear and damage before each use of the vehicle. Use the strap adjusters to tighten any loose straps. Promptly replace worn or damaged cab nets with new cab nets, available from your authorized POLARIS dealer.

Storage Bag

The storage bag is attached to the cab frame behind the seats. Use the storage bag to carry lightweight items such as water bottles or apparel. Do not carry heavy items in the storage bag.



FEATURES AND CONTROLS

Fuel Cap

 Never allow a child to refuel or handle gasoline.

The fuel tank filler cap is located on the right-hand side of the vehicle near the passenger seat.

Use POLARIS Carbon Clean fuel treatment at each fill. Follow the mixing directions on the container. See page 94 for the part numbers of POLARIS products.

When refueling, always use either leaded or unleaded gasoline with a minimum pump octane number of 87 R+M/2 octane. Non-ethanol fuel is recommended. *Do not use fuel with ethanol content greater than 10 percent, such as E-85 fuel.*

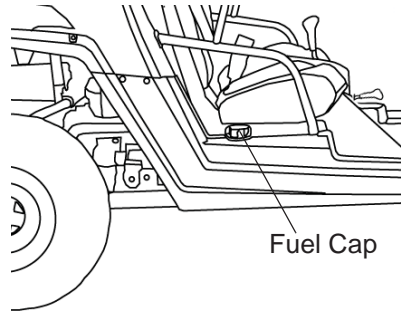

FEATURES AND CONTROLS

Ignition Switch

The ignition switch is a three-position, key-operated switch. Use the ignition switch to start the engine. See page 40 for starting procedures.

The key can be removed from the switch when it is in the OFF position.

OFF	The engine is off. Electrical circuits are off, except accessory 12V.
ON	Electrical circuits are on. Electrical equipment can be used.
START	Turn the key to the START position to engage the electric starter. The key returns to the ON position when released.



Ignition Switch

FEATURES AND CONTROLS

Gear Selector

F: Forward

N: Neutral

R: Reverse

The gear selector is located between the seats. To change gears, stop the vehicle, and with the engine idling, move the lever to the desired gear. Do not attempt to shift gears with engine speed above idle or while the vehicle is moving.

Gear Selector



Tip: Maintaining shift linkage adjustment is important to assure proper transmission function. Your POLARIS dealer can assist in resolving any shifting problems.

NOTICE: Do not attempt to shift the transmission while the vehicle is moving or damage to the transmission could result. Always shift when the vehicle is stationary and the engine is at idle.

Parking Brake

1. Apply the brakes.
2. When the vehicle is fully stopped, pull the parking brake lever rearward as far as possible to set the parking brake.
3. Stop the engine.
4. To release the parking brake, apply the brakes and push the lever toward the passenger seat and forward.
5. See page 64 for parking brake adjustment procedures.

Tip: Always set the parking brake whenever the vehicle is left unattended.



Operating the vehicle while the parking brake is engaged could cause an accident resulting in serious injury or death. It could also result in driveline or engine damage. Always be sure to disengage the parking brake before operating the vehicle.

FEATURES AND CONTROLS

Brake Pedal

Depress the brake pedal to slow or stop the vehicle. Apply the brakes while starting the engine.

Throttle Pedal

Push the pedal down to increase engine speed. Spring pressure returns the pedal to the rest position when released. Always check that the throttle pedal returns normally before starting the engine. Make sure there's adequate throttle pedal freeplay.

See page 70 for throttle pedal adjustment procedures.

This vehicle is equipped with a throttle release switch, which is designed to reduce the risk of a frozen or stuck throttle. If the throttle cable should stick in an open position when the operator releases the throttle pedal, engine speed will be limited to idle speed.

 The throttle release switch limits engine speed in the event of a throttle system malfunction. Modifications to the throttle release switch could result in failure to perform as designed, which could result in an accident. Do not attempt to modify the throttle control system or replace it with any after market throttle mechanism. Always ensure that the throttle cable is installed and properly routed to the throttle control.

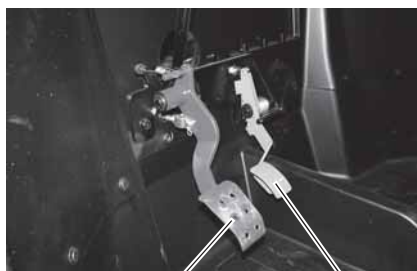

Brake
Pedal

Throttle
Pedal

FEATURES AND CONTROLS

Speed Control System

The speed of this vehicle is restricted to under 15 MPH (24 km/h) at manufacture. The speed limiting device may be adjusted by supervising adults when they determine that their child is capable of handling additional speed. The unrestricted top speed for this model is approximately 25 MPH (40 km/h).

The adjustable throttle limiting screw is located behind the throttle pedal. Use the following procedure to control how far the throttle opens.

1. Loosen the jam nut.
2. Turn the screw outward to reduce speed. Turn the screw inward to increase speed.

Tighten the jam nut after adjusting.

OPERATION

WARNING

Failure to operate the vehicle properly can result in a collision, loss of control, accident or rollover, which may result in serious injury or death. Read and understand all safety warnings outlined in the safety section of this owner's manual.

Vehicle Break-in Period

The break-in period for your new POLARIS vehicle is defined as the first ten hours of operation, or the time it takes to use the first two full tanks of gasoline.

No single action on your part is as important as a proper break-in period. Careful treatment of a new engine and drive components will result in more efficient performance and longer life for these components. Perform the following procedures carefully.

NOTICE: Excessive heat build-up during the first three hours of operation will damage close-fitted engine parts and drive components. Do not operate at full throttle or high speeds during the first three hours of use.

Mixing brands or using a non-recommended oil may cause serious engine damage. Always use the recommended oil. Never substitute or mix oil brands.

Vehicle Break-in Period

Engine and Drivetrain Break-in

1. Fill the fuel tank with gasoline. Always exercise extreme caution whenever handling gasoline. Never allow a child to handle gasoline.
2. Check the oil level. See page 59. Add the recommended oil as needed to maintain the oil level in the safe operating range.
3. Complete the New Operator Driving Procedures outlined on pages 42-43.
4. Avoid aggressive use of the brakes. See Brake System Break-in below.
5. Vary throttle positions. Do not operate at sustained idle.
6. Perform regular checks on fluid levels, controls and areas outlined on the daily pre-ride inspection checklist. See page 38.
7. Change the engine oil at 10 hours or one month.
8. Adjust and lubricate the drive chain at 10 hours or one month.

Brake System Break-in

Apply only moderate braking force for the first 50 stops. Aggressive or overly forceful braking when the brake system is new could damage brake pads and rotors.

CVT Break-in (Clutches/Belt)

A proper break-in of the clutches and drive belt will ensure a longer life and better performance. Break in the clutches and belt by operating at slower speeds during the break-in period as recommended. Avoid aggressive acceleration and high speed operation during the break-in period.

OPERATION

Pre-Ride Inspection

Failure to inspect and verify that the vehicle is in safe operating condition before operating increases the risk of an accident. Always inspect the vehicle before each use to make sure it's in safe operating condition.

Item	Remarks	Page
Brake system/pedal travel	Ensure proper operation	34 71
Brake fluid	Ensure proper level	73
Front suspension	Inspect, lubricate if necessary	58
Rear suspension	Inspect, lubricate if necessary	58
Steering	Ensure free operation	74
Tires	Inspect condition and pressure	23 76
Wheels/fasteners	Inspect, ensure fastener tightness	77
Frame nuts, bolts, fasteners	Inspect, ensure tightness	-
Fuel and oil	Ensure proper levels	31 59
Grass and debris	Remove grass and debris from the vehicle, especially on the underside and near the exhaust system	-
Throttle	Ensure proper operation	69
Indicator lights/switches	Ensure proper operation	-
Air filter	Inspect and clean or replace	67
Daytime running lights	Ensure proper operation	78
Brake light	Ensure proper operation	-
Seat Latches	Move the seats forward and rearward to ensure correct installation	26
Seat Belts	Check length of belt for damage, check latches for proper operation	28
Cab Nets	Check for wear or damage, ensure proper installation	30

Safe Operation Practices

1. Complete the New Operator Driving Procedures outlined on pages 42-43.
2. Do not ride at night or when visibility is poor (rain, fog, dusk). Your vehicle doesn't have lights that are designed for driving in these conditions.
3. Never tow objects or carry loads with this vehicle.
4. Engine exhaust fumes are poisonous. Never start the engine or let it run in an enclosed area. Never allow a child to handle gasoline.
5. Never install accessories not approved by POLARIS for use on this vehicle.
6. Ride this vehicle only in areas permitted by a supervising adult. Never operate the vehicle on pavement or on any public street, road or highway, including dirt and gravel roads.
7. Drive in a manner appropriate for your skills and operating conditions. Never operate at excessive speeds. DO NOT attempt to do power slides, "donuts", jumps or other driving stunts. Keep both hands on the steering wheel at all times.
8. Never consume alcohol or drugs before or while operating this vehicle.
9. Always use the size and type of tires specified for your vehicle. Always maintain proper tire pressure.
10. Never operate a damaged vehicle. After any rollover or accident, have a qualified service dealer inspect the entire machine for possible damage.
11. Never operate the vehicle on a frozen body of water.
12. Do not touch hot exhaust system components. Always keep combustible materials away from the exhaust system.
13. Always remove the ignition key when the vehicle is not in use to prevent unauthorized use.

OPERATION

Starting the Engine

1. Sit in the driver's seat and fasten the seat belt.
2. Secure the cab nets.
3. Place the transmission in neutral. Set the parking brake.
4. Apply the brakes.
5. Do not press the throttle pedal while starting the engine.
6. Turn the ignition key past the ON/RUN position to START. Engage the starter for a maximum of five seconds. Release the key when the engine starts.

NOTICE: Operating the vehicle immediately after starting could cause engine damage. Allow the engine to warm up for several minutes before operating the vehicle.

7. If the engine does not start within five seconds, return the ignition switch to the OFF position and wait five seconds. Repeat steps 6 and 7 until the engine starts.
8. Vary the engine RPM slightly with the throttle to aid in warm-up until the engine idles smoothly.
9. Release the parking brake before driving.

Stopping the Engine

1. Release the throttle pedal completely and brake to a complete stop.
2. Place the transmission in neutral.
3. Set the parking brake.
4. Stop the engine.

Braking

1. Release the throttle pedal completely. (When the throttle pedal is released completely and engine speed slows to near idle, the vehicle has no engine braking.)
2. Press on the brake pedal evenly and firmly. Practice starting and stopping (using the brakes) until you're familiar with the controls.

Parking the Vehicle

1. Stop the vehicle on a level surface. When parking inside a garage or other structure, be sure that the structure is well ventilated and that the vehicle is not close to any source of flame or sparks, including any appliance with pilot lights.
2. Place the transmission in neutral.
3. Set the parking brake.
4. Stop the engine.
5. Remove the ignition key to prevent unauthorized use.

OPERATION

New Operator Driving Procedures

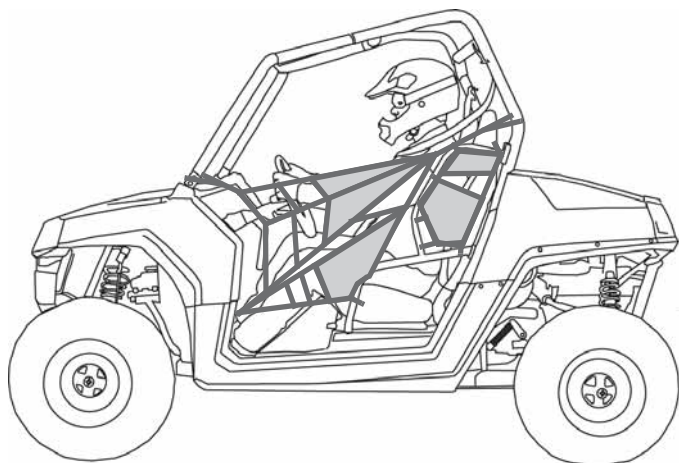

1. Read and understand this owner's manual and all warning and instruction labels before operating this vehicle.
2. Watch the instructional video with the supervising adult.
3. Review the section of this owner's manual about starting the engine, stopping the engine, braking and parking (pages 40-41).
4. Perform the pre-ride inspection (page 38).
5. The driver and all passengers must wear helmet, eye protection, gloves, long-sleeve shirt, long pants, over-the-ankle boots and seat belt at all times.
6. Do not operate or ride in this vehicle if the clearance between the top of your helmet and the overhead cab frame is less than 2 inches (5 cm).

(continued on next page)

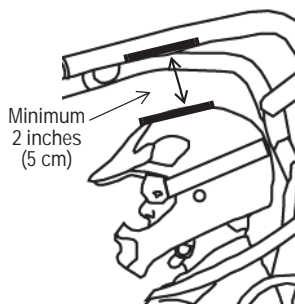

New Operator Driving Procedures

7. Select a level open area to practice driving. Make sure you have adult supervision and permission to drive in this area.
8. Sit in the driver's seat and fasten the seat belt.
9. Make sure all passengers secure their seat belts.
10. Make sure all cab nets are properly secured.
11. Do not carry a passenger until you have at least four hours of driving experience with this vehicle. See page 44.
12. Set the parking brake.
13. Place the transmission in neutral.
14. Start the engine.
15. Apply the brakes and shift into gear.
16. Release the parking brake.
17. Check your surroundings. Make sure the area is clear of people and obstacles.
18. Keeping both hands on the steering wheel, slowly release the brakes and press the throttle with your right foot to begin driving.
19. Drive slowly at first. Practice starting, stopping, turning, using the throttle and brakes and driving in reverse. Learn how the vehicle handles when making both left and right turns at a slow speed.
20. Increase speed only after mastering all maneuvers at a slow speed.
21. After you become skilled at making turns and begin to operate at faster speeds, follow these precautions:
 - Avoid sharp turns. Make turns gradually.
 - Never turn while applying heavy throttle.
 - Never turn the steering wheel abruptly.
 - Operate at speeds appropriate for your skills, the conditions and the terrain.
 - DO NOT attempt to do power slides, “donuts”, jumps or other driving stunts.

OPERATION

Driving with a Passenger

1. Complete the New Operator Driving Procedures outlined on pages 42-43.
2. Perform the pre-ride inspection. See page 38.
3. Do not carry a passenger until you have at least four hours of driving experience with this vehicle.
4. Never operate with a passenger under age 10. All riders must be able to sit with backs against the seat, both feet flat on the floor and both hands on the steering wheel (if driving) or on a passenger hand hold.
5. Make sure the passenger has at least 2 inches (5 cm) of clearance between his helmet and the top of the cab frame.
6. Never carry more than one passenger in this vehicle.
7. Never allow a passenger to ride on the back of the vehicle. Allow a passenger to ride only in the passenger seat.
8. Make sure the passenger is wearing helmet, eye protection, gloves, long-sleeve shirt, long pants and over-the-ankle boots. See page 10.
9. Make sure the passenger secures the seat belt.
10. Tell your passenger to always keep hands and feet inside the vehicle at all times.
11. Make sure all cab nets are properly secured.
12. Drive slowly. Vehicle handling may change with a passenger on board. Always travel at a speed appropriate for your skills, your passenger's skills, and operating conditions. Avoid unexpected or aggressive maneuvers that could cause discomfort or injury to a passenger.
13. Always follow all operating guidelines as outlined on safety labels and in this manual.



Driving on Slippery Surfaces

When driving on slippery surfaces such as wet trails, loose gravel, sand or ice, be alert for the possibility of skidding and sliding.

Follow these precautions when driving in slippery conditions:

1. Slow down before entering slippery areas.
2. Be alert, watch the path ahead and avoid quick turns, which can cause skids.
3. Correct a skid by turning the steering wheel in the direction of the skid. *Never apply the brakes during a skid.*

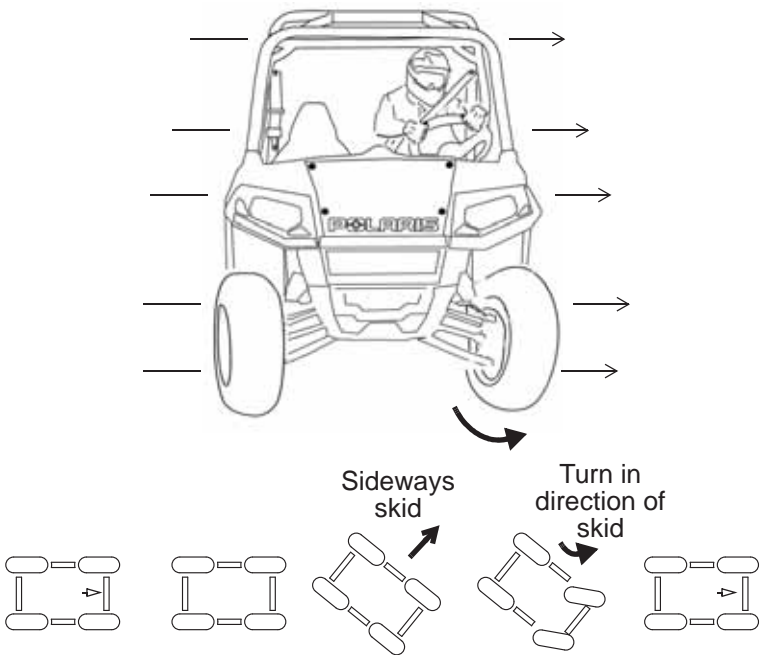

OPERATION

Driving Uphill

Whenever traveling uphill, follow these precautions:

1. Always check the terrain carefully before ascending a hill. Never drive on hills with excessively slippery or loose surfaces.
2. Avoid excessively steep hills (15° maximum).
3. Drive straight uphill.
4. Drive at a steady rate of speed. Never press the throttle suddenly.
5. Avoid unnecessary changes in speed or direction.
6. Never go over the crest of a hill at a high speed. An obstacle, a sharp drop, or another vehicle or person could be on the other side of the hill.
7. If the vehicle stalls while climbing a hill, apply the brakes. Place the transmission in reverse and slowly allow the vehicle to roll straight downhill while applying the brakes lightly to control speed.

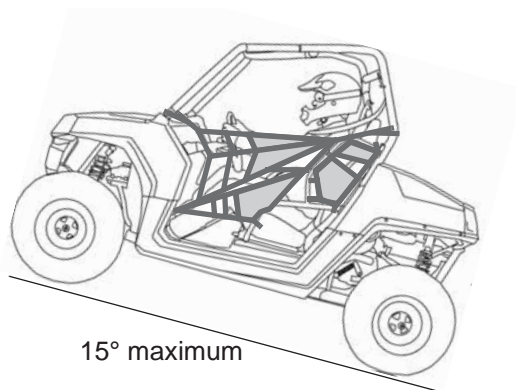

Driving on a Sidehill (Sidehilling)

Driving on a sidehill is not recommended. Driving on a sidehill improperly cause loss of control or rollover.

If crossing a hill is *unavoidable*, follow these precautions:

1. Drive slowly and use extreme caution.
2. If the vehicle begins to roll over, or if it feels as if it may roll over, *immediately* turn downhill.
3. Avoid obstacles and changes in terrain that may lower or raise one side of the vehicle or cause the vehicle to slide.
4. If the vehicle begins to slide downhill, immediately turn downhill to stop the slide, or stop the vehicle and maneuver slowly and carefully until the vehicle can be driven straight downhill.

Driving Downhill

Whenever driving down a hill, follow these precautions:

1. Avoid excessively steep hills (15° maximum).
2. Slow down. Never travel down a hill at high speed.
3. Always check the terrain carefully before driving down a hill. Never drive on hills with excessively slippery or loose surfaces.
4. Always drive down a hill with the transmission in forward gear. *Never “coast” or drive down a hill with the transmission in neutral.*
5. Avoid driving down a hill at an angle, which would cause the vehicle to lean sharply to one side. Always drive straight downhill.
6. Apply the brakes *lightly* to keep speed slow.

OPERATION

Driving Through Water

Your vehicle can drive through shallow water. Make sure the water is no deeper than the floor of the vehicle. Follow these precautions when driving through water:

1. Check water depth. Never drive through water that is deeper than the floor level.
2. After driving through water, test the brakes. Apply them lightly several times while driving slowly. The friction will help dry out the pads.



NOTICE: Major engine damage can result if the vehicle is not thoroughly inspected after operation in water. Perform the services outlined in the maintenance chart. See page 53. Give special attention to engine oil, transmission oil and all grease fittings.

If your vehicle becomes immersed or is operated in water that exceeds the floor level, *service is required before starting the engine.* Your POLARIS dealer can provide this service. If it's impossible to bring the vehicle in before starting the engine, perform the service outlined on page 79, and take the vehicle in for service at the first opportunity.

Driving Over Obstacles

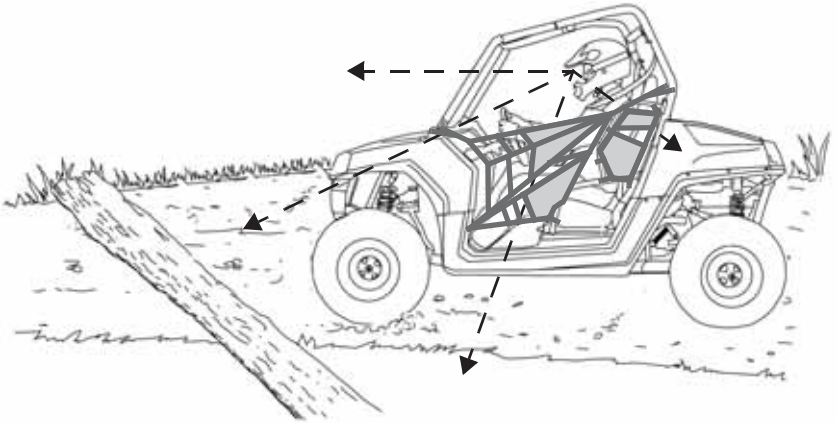

Follow these precautions when driving over obstacles:

1. Always check for obstacles before driving in a new area.
2. Look ahead and watch the terrain. Always be alert for hazards such as logs, rocks and low hanging branches.
3. Drive slowly and use extra caution when driving on unfamiliar terrain. Obstacles are not always clearly visible.
4. Do not drive over large obstacles such as large rocks and fallen trees. If it's unavoidable, use extreme caution and drive slowly.
5. Always have a passenger dismount and move away from the vehicle before driving over an obstacle that could cause a rollover.

OPERATION

Driving in Reverse

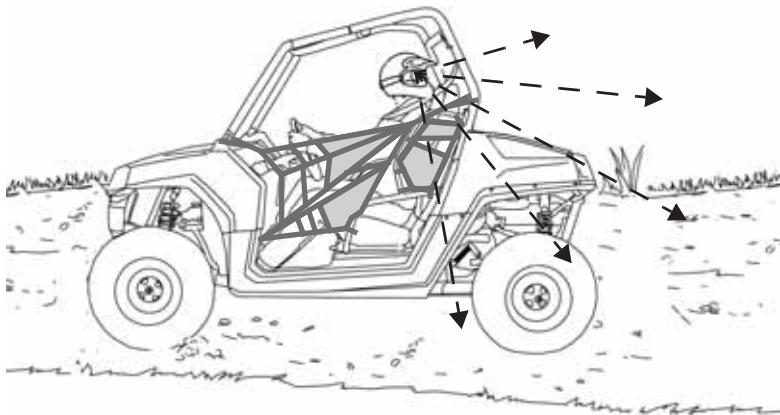

Follow these precautions when driving in reverse:

1. Always check for obstacles or people behind the vehicle.
2. Apply the throttle *lightly*. Never apply the throttle suddenly.
3. Back slowly.
4. Apply the brakes lightly for stopping.
5. Avoid making sharp turns.

Parking on an Incline

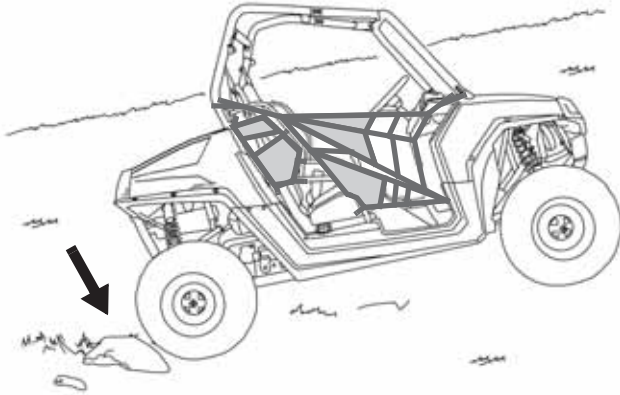

A rolling vehicle can result in serious injury. Avoid parking on an incline. If parking on an incline is *unavoidable*, follow these precautions:

1. Place the transmission in neutral.
2. Set the parking brake.
3. Stop the engine.
4. Always block the rear wheels on the downhill side.

EMISSION CONTROL SYSTEMS

Noise Emission Control System

Do not modify the engine, intake or exhaust components, as doing so may affect compliance with U.S.A. EPA noise control requirements (40 CFR 205) and local noise level requirements.

Operation on Public Lands in the U.S.A.

Your POLARIS vehicle has a spark arrester that was tested and qualified to be in accordance with the USFS standard 5100-1c. Federal law requires that this spark arrester be installed and functional when the vehicle is operated on public lands.

Operation of off-road vehicles on public lands in the U.S.A. is regulated by 43 CFR 420. Violations are subject to monetary penalties. Federal regulations can be viewed online at www.gpoaccess.gov/ecfr/.

Crankcase Emission Control System

This engine is equipped with a closed crankcase system. Blow-by gases are forced back to the combustion chamber by the intake system. All exhaust gases exit through the exhaust system.

Exhaust Emission Control System

Exhaust emissions are controlled by engine design. An electronic fuel injection (EFI) system controls fuel delivery. The engine and EFI components are set at the factory for optimal performance and are not adjustable.

The emissions label is located on the frame behind the right front wheel.

Electromagnetic Interference

This spark ignition system complies with Canadian ICES-002.

This vehicle complies with the EMC requirements of European directives 97/24/EC and 2004/108/EC.

Non-ionizing Radiation: This vehicle emits some electromagnetic energy. People with active or non-active implantable medical devices (such as heart monitoring or controlling devices) should review the limitations of their device and the applicable electromagnetic standards and directives that apply to this vehicle.

Periodic Maintenance Chart

Any qualified repair shop or person may maintain, replace or repair the emission control devices or systems on your vehicle. An authorized POLARIS dealer can perform any service that may be necessary for your vehicle. POLARIS also recommends POLARIS parts for emissions-related service, however equivalent parts can be used.

It is a potential violation of the Clean Air Act if a part supplied by an aftermarket parts manufacturer reduces the effectiveness of the vehicle's emission controls. Tampering with emission controls is prohibited by federal law.

Owners are responsible for performing the scheduled maintenance identified in this owner's manual.

Careful periodic maintenance will help keep your vehicle in the safest, most reliable condition. Inspection, adjustment and lubrication of important components are explained in the periodic maintenance chart.

Inspect, clean, lubricate, adjust and replace parts as necessary. When inspection reveals the need for replacement parts, genuine POLARIS parts are available from your POLARIS dealer. Equivalent parts may be used for emissions-related service.

Record maintenance and service in the Maintenance Log beginning on page 106.

Service and adjustments are important for proper vehicle operation. If you're not familiar with safe service and adjustment procedures, a qualified dealer can perform these operations.

Vehicles subjected to heavy or severe use patterns must be inspected and serviced more frequently.

Severe Use Definition

- Frequent immersion in mud, water or sand
- Racing or race-style high RPM use
- Prolonged low speed operation
- Extended idle
- Short trip cold weather operation

Pay special attention to the oil level. A rise in oil level during cold weather can indicate contaminants collecting in the oil sump or crankcase. Change oil immediately if the oil level begins to rise. Monitor the oil level, and if it continues to rise, discontinue use and determine the cause. Your POLARIS dealer can assist.

MAINTENANCE

Periodic Maintenance Chart

Maintenance Chart Key

Symbol	Description
▶	Perform these operations more often for vehicles subjected to severe use.
D	Have an authorized POLARIS dealer or other qualified person perform these services.

WARNING! Improperly performing the procedures marked with a “D” could result in component failure and lead to serious injury or death. Have an authorized POLARIS dealer or other qualified person perform these services.

MAINTENANCE

Periodic Maintenance Chart

Perform all services at whichever maintenance interval is reached first.

Item	Maintenance Interval (whichever comes first)			Remarks
	Hours	Calendar	Miles (Km)	
Steering	-	Daily	-	Check each day before driving the vehicle. Make adjustments as needed. See the Pre-Ride Checklist on page 38.
Front suspension	-		-	
Rear suspension	-		-	
Tires	-		-	
Brake fluid level	-		-	
Brake pedal travel	-		-	
Brake system	-		-	
Wheels/fasteners	-		-	
Frame fasteners	-		-	
Engine oil level	-		-	
▶ Air filter	-	Daily	-	Inspect; clean often; replace as needed
Daytime running lights/taillight	-	Daily	-	Check operation
Drive chain	-	Daily	-	Inspect daily; adjust and lubricate if needed
CVT housing (if equipped)	-	Weekly	-	Drain water as needed, check often if driving in wet conditions
▶ D Brake pad wear	10	Monthly	100 (160)	Inspect periodically
▶ Engine oil change (break-in)	10	1 M	-	Perform a break-in oil change at one month
Drive chain (break-in)	10	1 M	-	Adjust and lubricate
Fuel System	25	Monthly	-	Inspect; cycle key to pressurize fuel pump; check lines and fittings for leaks and abrasion
Battery	25	Monthly	250 (400)	Check terminals; clean; test
▶ Main gearcase oil	25	Monthly	250 (400)	Inspect level; change yearly

▶ Perform these procedures more often for vehicles subjected to severe use.

D Have an authorized POLARIS dealer or other qualified person perform these services.

MAINTENANCE

Periodic Maintenance Chart

	Item	Maintenance Interval (whichever comes first)			Remarks
		Hours	Calendar	Miles (Km)	
▶	Engine breather filter (if equipped)	25	Monthly	150 (250)	Inspect; replace if necessary
▶	Engine oil change	30	6 M	300 (480)	Perform a break-in oil change at one month
▶	General lubrication	50	3 M	500 (800)	Lubricate all fittings, pivots, cables, etc.
D	Throttle release switch	50	6 M	300 (480)	Inspect; adjust; lubricate; replace if necessary
	Shift Linkage	50	6 M	500 (800)	Inspect, lubricate, adjust
D	Steering	50	6 M	500 (800)	Lubricate
▶	Front Suspension	50	6 M	500 (800)	Lubricate
▶	Rear Suspension	50	6 M	500 (800)	Lubricate
D	Fuel system/filter	100	12 M	600 (1000)	Cycle key to pressurize fuel pump; check for leaks at fill cap, fuel lines/rail and fuel pump; replace lines every two years
▶	Spark plug	100	12M	600 (1000)	Inspect; replace as needed

▶ Perform these procedures more often for vehicles subjected to severe use.

D Have an authorized POLARIS dealer or other qualified person perform these services.

MAINTENANCE

Periodic Maintenance Chart

Item	Maintenance Interval (whichever comes first)			Remarks
	Hours	Calendar	Miles (Km)	
▶ Engine mounts	100	12 M	1000 (1600)	Inspect
Exhaust muffler/ pipe	100	12 M	1000 (1600)	Inspect
D Ignition timing	100	12 M	1000 (1600)	Inspect
▶ Wiring	100	12 M	1000 (1600)	Inspect for wear, routing, security; apply dielectric grease to connectors subjected to water, mud, etc.
D Clutches (drive and driven)	100	12 M	1000 (1600)	Inspect; clean; replace worn parts
Drive belt	100	12 M	1000 (1600)	Inspect; replace as needed
D Front wheel bearings	100	12 M	1000 (1600)	Inspect; replace as needed
D Brake fluid	200	24 M	2000 (3200)	Change every two years
Spark arrester	300	36 M	3000 (4800)	Clean out
D Toe adjustment	-			Inspect periodically; adjust when parts are replaced

- ▶ Perform these procedures more often for vehicles subjected to severe use.
- D Have an authorized POLARIS dealer or other qualified person perform these services.

MAINTENANCE

Lubrication Recommendations

Check and lubricate all components at the intervals outlined in the Periodic Maintenance Chart beginning on page 53, or more often under severe use, such as wet or dusty conditions. Items not listed in the chart should be lubricated at the general lubrication interval.

Item	Lube	Method
Engine Oil	PS-4 Extreme Duty 10W-50 4-Cycle Oil	See page 59.
Brake Fluid	DOT 4 Brake Fluid	See page 73.
Transmission Oil (Main Gearcase)	AGL Gearcase Lubricant & Transmission Fluid	See page 61.
Drive Chain	POLARIS Chain Lube or SAE 80/90	See page 62.
A-Arm Pivots	POLARIS All Season Grease or grease conforming to NLGI No. 2	Grease at general lubrication interval, also after washing vehicle or driving in water.
▶ Steering Arm Pivots		

▶ Perform these procedures more often for vehicles subjected to severe use.

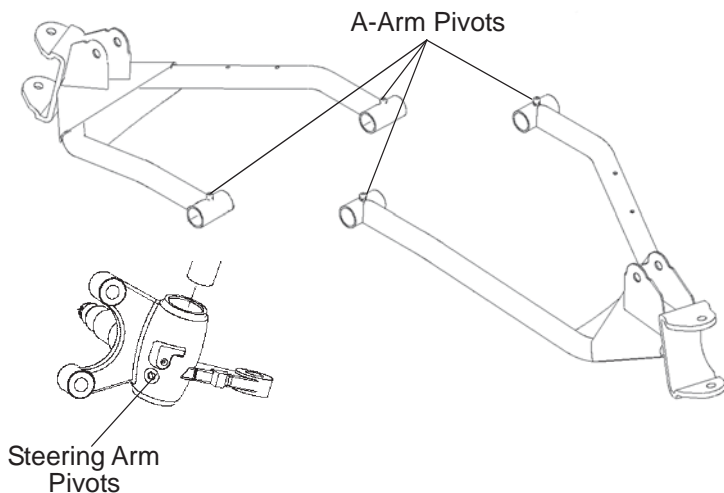

Engine Oil

Oil Recommendations

Always check and change the engine oil at the intervals outlined in the Periodic Maintenance Chart beginning on page 53. POLARIS recommends the use of POLARIS PS-4 Extreme Duty 10W-50 4-Cycle Oil for this vehicle. Oil may need to be changed more frequently if POLARIS oil is not used. Do not use automotive oil. See page 94 for the part numbers of POLARIS products.

NOTICE: Mixing brands or using a non-recommended oil may cause serious engine damage. Always use the recommended oil. Never substitute or mix oil brands.

Oil Check

Maintain the oil level within the safe range on the dipstick. Do not overfill.

1. Position the vehicle on a level surface.
2. Remove the dipstick. Wipe it dry with a clean cloth.
3. Reinstall the dipstick completely.
4. Remove the dipstick and check the oil level.

Tip: A rising oil level between checks in cool weather driving can indicate contaminants such as gas or moisture collecting in the crankcase. If the oil level is over the full/safe mark, change the oil immediately.

5. Add the recommended oil as needed.
6. Reinstall the dipstick.

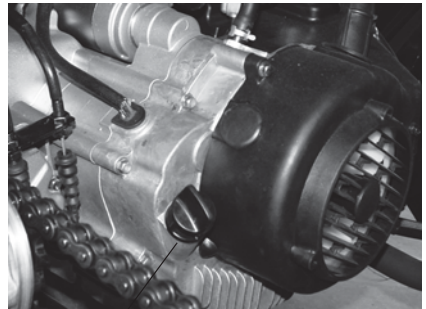

Dipstick

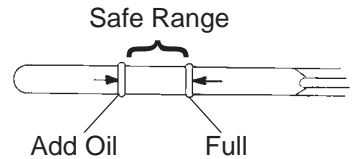

MAINTENANCE

Engine Oil

Oil Change

1. Position the vehicle on a level surface. Set the parking brake.
2. Clean the area around the pre-filter plug.
3. Start the engine. Allow it to idle for two to three minutes.
4. Stop the engine.



Hot oil can cause burns to skin. Do not allow hot oil to contact skin.

5. Place a drain pan under the engine crankcase.
6. Remove the pre-filter plug. Allow the oil to drain completely.
7. Wash the oil pre-filter screen with solvent to remove debris. Allow the screen to air dry.
8. Clean the pre-filter plug. Install a new sealing washer on the plug. The sealing surfaces on the plug and crankcase should be clean and free of burrs, nicks or scratches.
9. Reassemble the pre-filter screen and spring to the pre-filter plug.
10. Reinstall the pre-filter drain plug. Torque to 11 ft. lbs. (15 Nm).
11. Remove the dipstick. Add 37 oz. (1.1 liters) of the recommended oil. Do not overfill. See the specifications section beginning on page 92 for capacities.
12. Reinstall the dipstick.
13. Start the engine. Allow it to idle for one to two minutes.
14. Stop the engine and inspect for leaks.
15. Check the oil level. Add oil as needed to bring the level to the upper mark on the dipstick.
16. Dispose of used oil properly.



Transmission (Main Gearcase)

Always check and change the fluid at the intervals outlined in the Periodic Maintenance Chart beginning on page 53. POLARIS recommends the use of AGL Gearcase Lubricant & Transmission Fluid for this vehicle.

Fluid Check

The fill plug is located on the rear of the gearcase. Access the fill plug through the left rear wheel well. Maintain the fluid level at the bottom of the fill plug hole.

1. Position the vehicle on a level surface.
2. Remove the fill plug.
3. Check the fluid level.
4. Add the recommended fluid as needed.
5. Reinstall the fill plug.



Fluid Change

The drain plug is located on the bottom of the gearcase.

1. Remove the fill plug.
2. Place a drain pan under the drain plug.
3. Remove the drain plug. Allow the fluid to drain completely.
4. Clean the drain plug.
5. Reinstall the drain plug with a new o-ring. Torque to 11 ft. lbs. (15 Nm).
6. Add 23.7 oz. (700 ml) of the recommended fluid to the fill hole. Maintain the fluid level at the bottom of the fill plug hole. Do not overfill.
7. Reinstall the fill plug.
8. Check for leaks.
9. Discard used fluid properly.

MAINTENANCE

Drive Chain Lubrication

Lubricate the drive chain with POLARIS chain spray lube or an approved chain lube at the general lubrication interval specified in the Periodic Maintenance Chart beginning on page 53. Lubricate more often under severe use, such as in dirty or wet conditions. See page 94 for the part numbers of POLARIS products.

NOTICE: Washing the drive chain with a high pressure washer or gasoline can cause premature wear and drive chain failure. Don't use a high pressure washer or gasoline to clean the drive chain.

Adjusting or operating the vehicle with improper rear drive chain slack can result in severe damage to the transmission and drive components. Always make sure the slack is within the stated specifications.

Drive Chain Slack

1. Check the amount of chain slack by moving the vehicle slightly forward to gain slack at the top side of the chain.
2. Raise the rear of the vehicle and support securely under the mainframe. Allow the swing arm to hang at full shock extension without touching the ground. This establishes the tightest chain position.
3. Pull down on the chain tensioner to move it out of the way, then measure chain slack. It should have 1/4"-1/2" (6-12 mm) deflection.
4. If the chain needs adjustment, use the procedure on page 63.

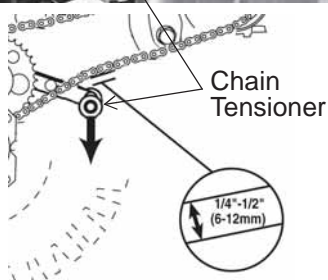

Drive Chain Slack Adjustment

1. Loosen the four rear housing mount bolts (two on each side).
2. Loosen the chain adjuster lock nuts.
3. Turn the chain adjusters clockwise to 1/4"-1/2" (6-12 mm) deflection.
4. Tighten the chain adjuster lock nuts to 18 ft. lbs. (25 Nm). Hold the adjuster stud securely while tightening the nut to avoid breaking the stud.
5. Tighten the four rear housing mount bolts to 43 ft. lbs. (60 Nm).

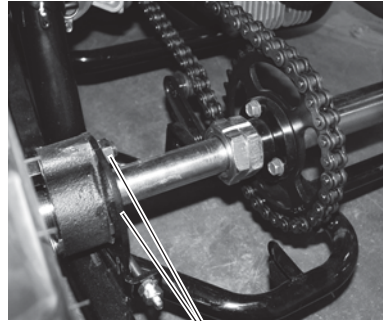

Housing Mount Bolts



Chain Adjusters

MAINTENANCE

Parking Brake Cable Freeplay Adjustment

1. Inspect and perform any needed service on the brake pads before adjusting parking brake cable freeplay.
2. Make sure the parking brake is NOT set (lever is DOWN).
3. Pull the brake cable back to inspect freeplay between the cable end and the caliper bracket. Freeplay should be 1/16" - 1/8" (1.5-3 mm).
4. To adjust freeplay, loosen the jam nut. Turn the in-line adjuster nut outward to decrease freeplay. Turn the adjuster nut inward to increase freeplay.
5. Tighten the jam nut against the adjuster nut.



Inspect
Freeplay

In-line
Adjuster Nut

Jam
Nut

Parking Brake Adjustment

1. Inspect and perform any needed service on the brake pads before adjusting the parking brake.
2. Position the vehicle on a level surface. Place the transmission in neutral.
3. Carefully elevate the rear of the vehicle slightly. Use an appropriate lift.
4. Loosen the jam nut on the parking brake adjustment bolt.
5. While rotating the rear wheels by hand, tighten the adjustment bolt until significant brake drag is detected. Then back the adjustment bolt out 1/4 turn.
6. Hold the adjustment bolt in place and tighten the jam nut securely against the lever arm.
7. Check parking brake lever movement. Verify that the rear wheels rotate freely with the parking brake off (lever in DOWN position) and that the vehicle will not move when the parking brake is applied (lever in UP position).
8. Verify that the park brake lever stays in the UP position when the brake is fully applied.

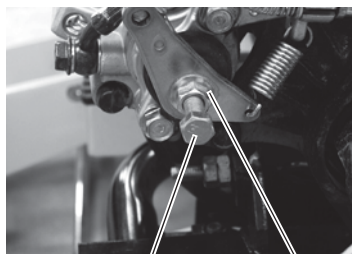

Adjustment Bolt

Jam Nut

Spark Plug Spark Plug Gap/Torque

Electrode Gap	New Plug Torque	Used Plug Torque
0.6-0.7 mm	9-11 ft. lbs. (12-15 Nm)	17-20 ft. lbs. (23-27 Nm)

NOTICE: Using non-recommended spark plugs can result in serious engine damage. Use POLARIS-recommended spark plugs or their equivalent. See page 92.

Spark plug condition is indicative of engine operation. The spark plug firing end condition should be read after the engine is warmed up and the vehicle is driven at higher speeds. Immediately check the spark plug for correct color. See page 65.

 A hot exhaust system and engine can cause burns. Wear protective gloves when removing a spark plug for inspection.

Spark Plug Condition Normal Plug

The normal insulator tip is gray, tan or light brown. There will be few combustion deposits. The electrodes are not burned or eroded. This indicates the proper type and heat range for the engine and the service.

Tip: The tip should not be white. A white insulator tip indicates overheating, caused by use of an improper spark plug or incorrect throttle body adjustments.

Wet Fouled Plug

The wet fouled insulator tip is black. A damp oil film covers the firing end. There may be a carbon layer over the entire nose. Generally, the electrodes are not worn. General causes of fouling are excessive oil, use of non-recommended injection oil or incorrect throttle body adjustments.

Spark Plug Removal and Replacement

1. Remove the spark plug cap.
2. Using the spark plug wrench provided in the tool kit, remove the plug by rotating it counter-clockwise.
3. Reverse the procedure for spark plug installation. Torque to specification. See page 65.

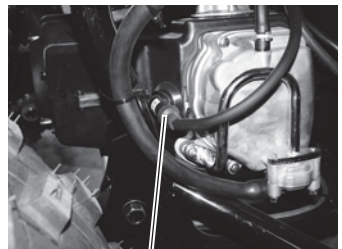

Spark Plug
(right rear wheel well)

MAINTENANCE

Constant Variable Transmission (CVT) System

WARNING

Failure to comply with the instructions in this warning can result in severe injury or death.

Do not modify any component of the CVT system. Doing so may reduce its strength so that a failure may occur at a high speed. The CVT system has been precision balanced. Any modification will cause the system to be out of balance, creating vibration and additional loads on components.

The CVT system rotates at high speeds, creating large amounts of force on clutch components. Extensive engineering and testing has been conducted to ensure the safety of this product. However, as the owner, you have the following responsibilities to make sure this system remains safe:

- Always follow all recommended maintenance procedures. See your POLARIS dealer, or other qualified person, for service and repair assistance.
- This CVT system is intended for use on POLARIS products only. Do not install it in any other product.
- Always make sure the CVT housing is securely in place during operation.

CVT Drying

There may be some instances when water is accidentally ingested into the CVT system. Use the following instructions to dry it out before operating. The drain plug is located on the bottom of the CVT cover.

1. Remove the drain plug. Allow the water to drain. Reinstall the drain plug.
2. Shift the transmission to neutral. Set the parking brake.
3. Start the engine. Apply varying throttle for 10-15 seconds to expel the moisture and air-dry the belt and clutches. Do not hold the throttle wide open for more than 10 seconds.
4. Allow the engine RPM to settle to idle speed.
5. Test for belt slippage. If the belt slips, repeat the process.
6. Your vehicle requires service as soon as possible. Your POLARIS dealer can assist.

NOTICE: Exposure to salt water will cause corrosion to metal components. If your vehicle is operated in salt water areas, rinse it off frequently with fresh water.

Filter Systems

Air Filter

Always change the air filter at the intervals outlined in the Periodic Maintenance Chart beginning on page 53. Access the air box through the access cover on the forward surface of the rear body panel.

1. Move or remove the storage bag. Remove the four (4) access cover fasteners to remove the access cover.
2. Release the air box cover spring clips and remove the cover.
3. Loosen the air filter clamp. Remove the air filter.
4. Clean away any oil or sediments in the air box.
5. Apply a commercially available chassis lubricant to the inside lip of the new air filter. Install the filter and tighten the clamp.
6. Reinstall the air box cover and secure the clips.

NOTICE: Never operate the vehicle with the filter element removed. Dirt will enter the engine, causing rapid wear and severe damage to the engine.

7. Reinstall the access cover and storage bag.

Access Cover

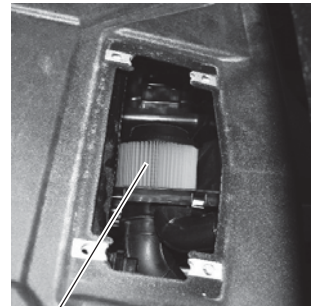

Filter

Lubricant



MAINTENANCE

Spark Arrester

⚠ WARNING

Failure to heed the following warnings while servicing the spark arrester could result in serious injury or death.

- Do not perform service on the spark arrester while the system is hot. Allow components to cool sufficiently before proceeding.
- Wear eye protection and gloves.
- Never operate without the spark arrester.
- Never run the engine in an enclosed area. Exhaust contains poisonous carbon monoxide gas.

To remove accumulated carbon, clean the spark arrester at the intervals recommended in the Periodic Maintenance Chart beginning on page 53.

1. Remove the six bolts and remove the arrester from the end of the muffler.
2. Use a non-synthetic brush to clean the arrester screen. A synthetic brush may melt if components are warm. If necessary, blow debris from the screen with compressed air.
3. Inspect the screen for wear and damage. Replace the arrester if damage is found.
4. Reinstall the arrester.
5. Torque the bolts to 7 ft. lbs. (9.5 Nm).



Arrester Screen

Throttle System

⚠ WARNING

Failure to check or maintain proper operation of the throttle system can result in an accident and lead to serious injury or death if the throttle pedal sticks during operation.

Never start or operate this vehicle if it has a sticking or improperly operating throttle pedal.

Immediately contact your POLARIS dealer or other qualified person for service if throttle problems arise.

Always check the pedal for free movement and return before starting the engine and occasionally during operation.

Throttle Freeplay

If the throttle pedal has excessive play due to cable stretch or misadjustment, it will cause a delay in throttle response, especially at low engine speed. The throttle may also not open fully. If the throttle pedal has no freeplay, the throttle may be hard to control, and the idle speed may be erratic.

Check the throttle pedal freeplay at the intervals outlined in the Periodic Maintenance Chart beginning on page 53. Adjust the freeplay if necessary.

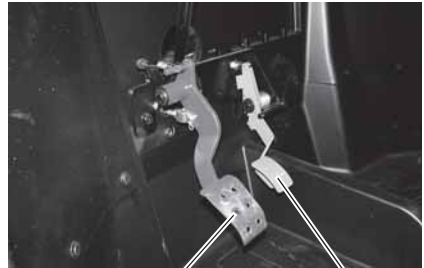

Brake Pedal

Throttle Pedal

Throttle Freeplay Inspection

1. Place the transmission in neutral. Set the parking brake.
2. Start the engine. Allow it to warm up thoroughly.
3. Measure the distance the throttle pedal moves before the engine begins to pick up speed. Freeplay should be 1/16 to 1/8 inches (1.5-3 mm).

MAINTENANCE

Throttle System

Throttle Freeplay Adjustment

Access the throttle cable adjuster through the right front wheel well.

1. Slide the cable adjuster boot off the cable adjuster.
2. Squeeze the end of the rubber boot and slide it far enough to expose the end of the inline cable adjuster.
3. Loosen the adjuster lock nut.
4. Move the cable adjuster until 1/16" to 1/8" (1.5-3 mm) of freeplay is achieved at the throttle pedal. See page 69. While adjusting, lightly flip the throttle pedal up and down.
5. Tighten the lock nut.
6. Apply a small amount of grease to the inside of the boot and slide it over the cable adjuster to its original position.

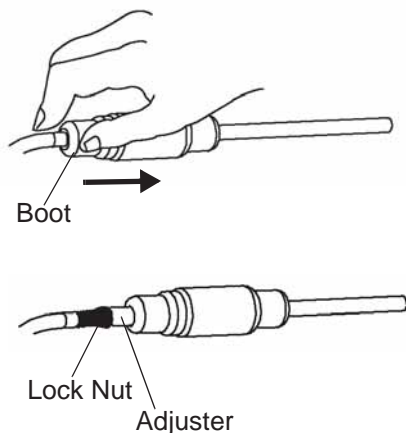
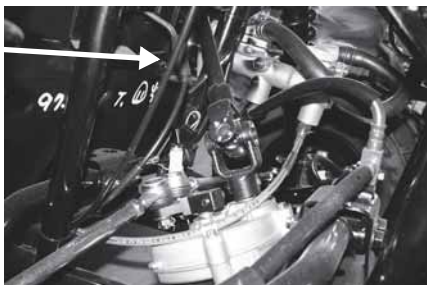

Brakes

The front and rear brakes are hydraulic disc type brakes activated by the brake pedal. See page 34.

Always check brake pedal travel and the brake fluid reservoir level before each use of the vehicle. When applied, the brake pedal should feel firm. Any sponginess would indicate a possible fluid leak or low brake fluid level, which must be corrected before riding. See page 73 for brake fluid information.

If you discover any irregularities in brake system operation, including excessive pedal travel, contact your dealer for proper diagnosis and repairs.



Operating the vehicle with a spongy brake pedal can result in loss of braking, which could cause an accident resulting in severe injury or death. Never operate the vehicle with a spongy-feeling brake pedal.

MAINTENANCE

Brakes

Brake Inspection

1. Check the brake system for fluid leaks.
2. Check the brake pedal for excessive travel or a spongy feel.
3. Check the brake pads for wear, damage and looseness.
4. Inspect the brake pad wear surface for excessive wear.
5. Change pads when the friction material is worn to .40" (1 mm).
6. Check the surface condition of the brake discs. Measure the thickness of the front and rear discs. Replace a disc if the thickness is less than .170" (4.32 mm).
7. Check brake system hoses and fittings for cracks, deterioration, abrasion and leaks. Tighten any loose fittings and replace any worn or damaged parts.

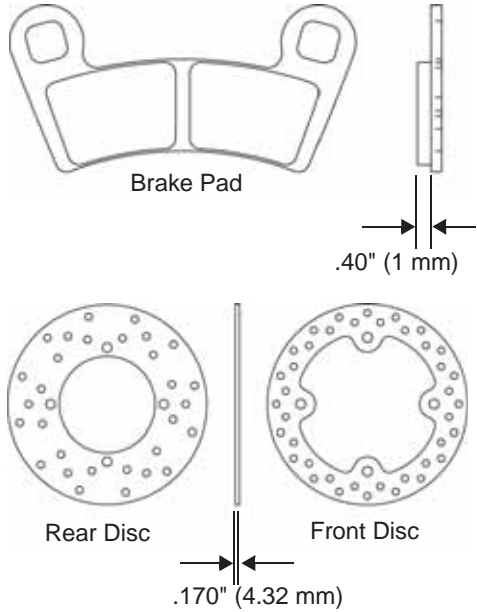

Brakes

Brake Fluid

Inspect the level of the brake fluid before each operation. If the fluid level is low add DOT 4 brake fluid only. See page 94 for the part numbers of POLARIS products.

⚠ After opening a bottle of brake fluid, always discard any unused portion. Never store or use a partial bottle. Brake fluid is hygroscopic, meaning it rapidly absorbs moisture from the air. The moisture causes the boiling temperature of the brake fluid to drop, which can lead to early brake fade and the possibility of accident or severe injury.

Change the brake fluid every two years and any time the fluid becomes contaminated, the fluid level is below the minimum, or if the type and brand of the fluid in the reservoir are unknown. Access the brake fluid reservoir through the left front wheel well.

1. Position the vehicle on a level surface.
2. Place the transmission in neutral. Set the parking brake.
3. View the brake fluid level in the reservoir. The level should be between the maximum and minimum level lines. Add brake fluid as needed.
4. Apply the brake forcefully for a few seconds and check for fluid leakage around the fittings.

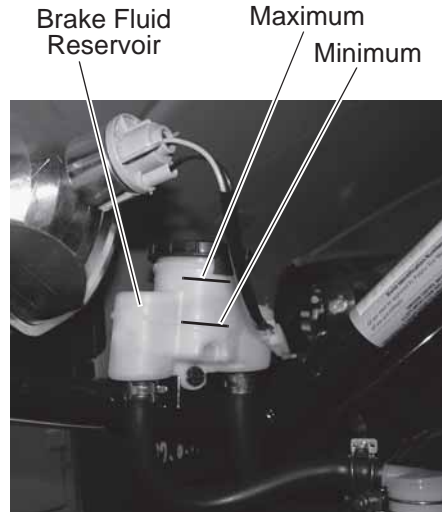

MAINTENANCE

Steering Wheel Inspection

Check the steering wheel for specified freeplay and smooth operation at the intervals outlined in the Periodic Maintenance Chart beginning on page 53.

1. Position the vehicle on level ground.
2. Lightly turn the steering wheel left and right.
3. There should be 0.8"-1.0" (20-25 mm) of freeplay.
4. If there is excessive freeplay or strange noises, or the steering feels rough or "catchy," have the steering system inspected by an authorized POLARIS dealer or other qualified service facility before operating the vehicle.

Shock Spring Adjustment

The front and rear shock absorber springs are adjustable to increase or decrease spring tension. Rotate the adjuster either clockwise or counter-clockwise to make adjustments. Always apply the same adjustment setting to *all four wheels*.

WARNING! Uneven adjustment may cause poor handling of the vehicle, which could result in an accident. Always adjust both the left and right spring preloads equally or have your POLARIS dealer perform the adjustments.

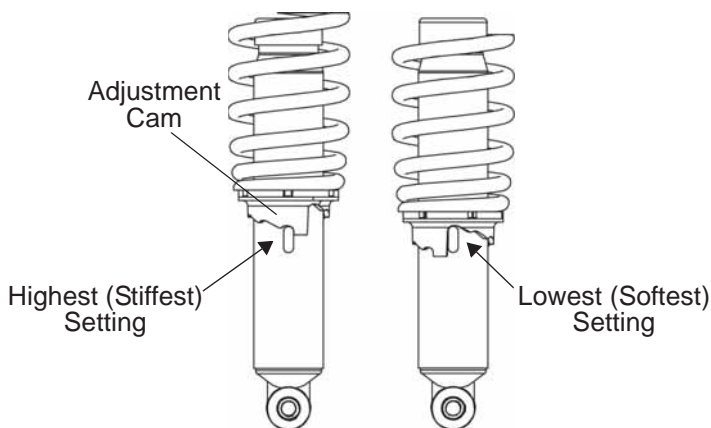

Toe Alignment

Use the following procedure to check the toe alignment of the vehicle. The recommended toe alignment is 1/8" to 1/4" (3-6 mm) toe out.

WARNING! Severe injury or death can result from improper toe alignment and adjustment. Do not attempt to adjust tie rod alignment. All tie rod adjustments should be performed by an authorized POLARIS dealer or other qualified service facility.

1. Position the vehicle on a level surface.
2. Set the handlebars in a straight-ahead position and secure them in this position.
3. Place a chalk mark on the center line of the front tires approximately 10" (25.4 cm) from the floor, or as close to the hub/axle center line as possible.



Make sure both marks are the same distance from the floor.

4. Measure the distance between the marks and record the measurement (1).
5. Move the vehicle to rotate the tires 180°. Position the wheels with the chalk marks at the rear of the tires, even with the hub/axle center line.
6. Measure the distance between the marks and record the measurement (2).
7. Subtract measurement 2 from measurement 1. The difference is the vehicle toe-out alignment.
8. If you discover improper alignment, see your POLARIS dealer for service.

MAINTENANCE

Tires

⚠ WARNING

Operating your vehicle with worn tires will increase the possibility of skidding, loss of control and an accident, which could result in serious injury or death. Always replace tires when the tread depth measures 1/8" (3 mm) or less.

Improper tire inflation or the use of non-standard size or type of tires may adversely affect vehicle handling, which could result in vehicle damage or personal injury. Always maintain proper tire pressure. Always use POLARIS-approved size and type of tires for this vehicle when replacing tires.

Tire Tread Depth

Always replace tires when tread depth is worn to 1/8" (3 mm) or less.

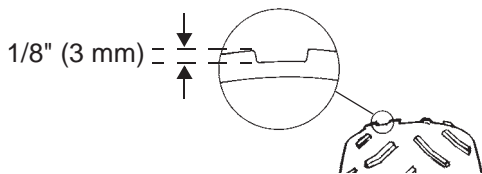

Front Wheel Hub Tightening

Front wheel bearing tightness and spindle nut retention are critical component operations. All service must be performed by your authorized POLARIS dealer or other qualified service facility.

Wheel Removal

1. Position the vehicle on a level surface.
2. Place the transmission in neutral. Set the parking brake. Stop the engine.
3. Loosen the wheel nuts slightly.
4. Elevate the side of the vehicle by placing a suitable stand under the frame.
5. Remove the wheel nuts. Remove the wheel.

Tires

Wheel Installation

1. Place the transmission in neutral.
2. Set the parking brake.
3. Place the wheel on the wheel hub with the valve stem toward the outside and the rotation arrows on the tire pointing toward forward rotation.
4. Attach the wheel nuts and finger tighten.
5. Carefully lower the vehicle to the ground.
6. Torque the wheel nuts to specification.

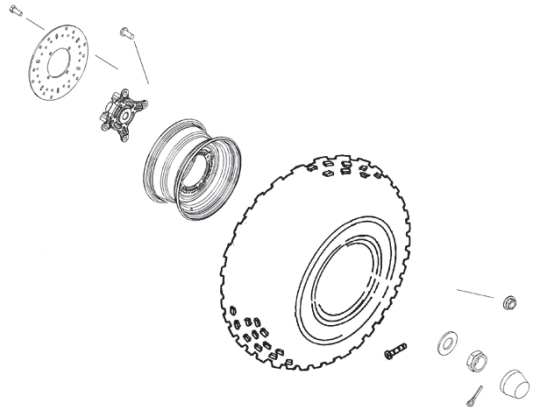

! Improperly installed wheels can adversely affect tire wear and vehicle handling, which can result in serious injury or death. Always ensure that all nuts are torqued to specification. Do not service axle nuts that have a cotter pin installed. Your POLARIS dealer can assist.

Wheel Nut Torque Specifications

Check the wheel nut torques occasionally and when they've been loosened for service.

Location	Nut Torque
Front Wheel	27 ft. lbs. (37 Nm)
Rear Wheel	27 ft. lbs. (37 Nm)

MAINTENANCE

Lights

Daytime Running Lights Lamp Replacement

If the daytime running lights do not operate, replace the lamps. POLARIS recommends that you install replacement lamps obtained from your authorized POLARIS dealer.

1. Disconnect the lights from the harness.
2. Remove the rubber cover from the back of the light assembly.
3. Press the lamp retainer inward and turn it counter-clockwise to remove it. Note the position of the lamp positioning tab, then carefully pull the lamp out.
4. Install the new lamp. Make sure the filament is horizontal.
5. Reinstall the lamp retainer. Press the retainer inward and turn it clockwise about 1/4 turn.
6. Start the engine to make sure the lights come on. If the lights do not operate, see your POLARIS dealer for service.
7. Reinstall the rubber cover, and reconnect the lights to the harness.

Tail Light Lamp Replacement

If the brakelight doesn't work, the lamp may need to be replaced.

1. Remove the two screws securing the lens cover. Remove the lens cover.
2. Remove the lamp and replace it with a new recommended lamp.
3. Test the light for proper operation.
4. Reinstall the lens cover.

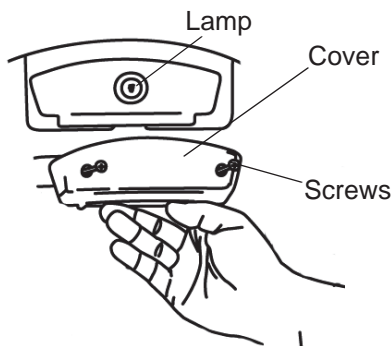

Vehicle Immersion

NOTICE: If your vehicle becomes immersed, major engine damage can result if the machine is not thoroughly inspected. Take the vehicle in for service before starting the engine. Your POLARIS dealer can provide this service.

If it's impossible to take your vehicle to a dealer before starting it, follow the steps outlined below.

1. Move the vehicle to dry land.
2. Check the air box. If water is present, dry the air box and replace the filter with a new filter. Thoroughly dry the air pre-filter. See page 67.
3. Remove the air box drain plug to drain any water. Reinstall the drain plug securely.
4. Remove the spark plug.
5. Turn the engine over several times using the electric start.
6. Dry the spark plug and reinstall it, or install a new plug.
7. Attempt to start the engine. If necessary, repeat the drying procedure.
8. Take the vehicle in for service as soon as possible, whether you succeed in starting it or not. Your POLARIS dealer can provide the required service.
9. If water has been ingested into the transmission follow the procedure on page 66 for drying.

MAINTENANCE

Battery

⚠ WARNING

Improperly connecting or disconnecting battery cables can result in an explosion and cause serious injury or death. When removing the battery, always disconnect the negative (black) cable first. When reinstalling the battery, always connect the negative (black) cable last.

⚠ WARNING

Battery electrolyte is poisonous. It contains sulfuric acid. Serious burns can result from contact with skin, eyes or clothing.

Antidote:

External: Flush with water.

Internal: Drink large quantities of water or milk. Follow with milk of magnesia, beaten egg, or vegetable oil. Call physician immediately.

Eyes: Flush with water for 15 minutes and get prompt medical attention.

Batteries produce explosive gases. Keep sparks, flame, cigarettes, etc. away. Ventilate when charging or using in an enclosed space. Always shield eyes when working near batteries. **KEEP OUT OF REACH OF CHILDREN.**

Your vehicle may have either a sealed battery, which requires little maintenance, or a conventional battery. A sealed battery can be identified by its flat covers on the top of the battery. A conventional battery has six filler caps on the top of the battery.

Always keep battery terminals and connections free of corrosion. If cleaning is necessary, remove the corrosion with a stiff wire brush. Wash with a solution of one tablespoon baking soda and one cup water. Rinse well with tap water and dry off with clean shop towels. Coat the terminals with dielectric grease or petroleum jelly. Be careful not to allow cleaning solution or tap water into a conventional battery.

Battery

Battery Removal

1. Remove the driver's seat. See page 26.
2. On conventional batteries, remove the battery vent tube (sealed batteries do not have a vent tube).
3. Disconnect the black (negative) battery cable first.
4. Disconnect the red (positive) battery cable last.
5. Lift the battery out of the vehicle. Be careful not to tip a conventional battery sideways, which could spill electrolyte.

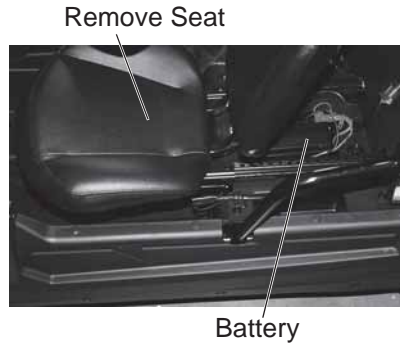

NOTICE: If electrolyte spills, immediately wash it off with a solution of one tablespoon baking soda and one cup water to prevent damage to the vehicle.

MAINTENANCE

Battery

Battery Installation

Using a new battery that has not been fully charged can damage the battery and result in a shorter life. It can also hinder vehicle performance. Follow the battery charging instructions on page 84 before installing the battery.

1. Ensure that the battery is fully charged.
2. Place the battery in the battery holder.
3. On conventional batteries, install the battery vent tube. The vent tube must be free of obstructions and securely installed. Route the tube away from the frame and vehicle body to prevent contact with electrolyte.



Battery gases could accumulate in an improperly installed vent tube and cause an explosion, resulting in serious injury or death. Always ensure that the vent tube is free of obstructions and is securely installed as recommended.

4. Coat the terminals with dielectric grease or petroleum jelly.
5. Connect and tighten the red (positive) cable first.
6. Connect and tighten the black (negative) cable last.
7. Verify that cables are properly routed.
8. Reinstall the driver's seat.

Battery

Battery Storage

Whenever the vehicle is not used for a period of three months or more, remove the battery from the vehicle, ensure that it's fully charged, and store it out of the sun in a cool, dry place. Check battery voltage each month during storage and recharge as needed to maintain a full charge. See page 84.

Tip: Battery charge can be maintained by using a POLARIS Battery Tender charger or by charging about once a month to make up for normal self-discharge. Battery Tender can be left connected during the storage period, and will automatically charge the battery if the voltage drops below a pre-determined point. See page 94 for the part numbers of POLARIS products.

Battery Fluid (Conventional Battery)

A poorly maintained battery will deteriorate rapidly. Check the battery fluid level often. Maintain the fluid level between the upper and lower level marks.

Add only distilled water. Tap water contains minerals that are harmful to a battery.

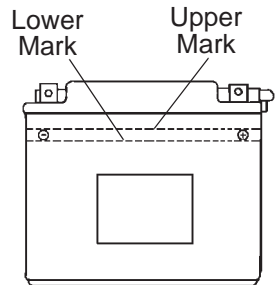

MAINTENANCE

Battery

Battery Charging (Conventional Battery)

1. Remove the battery from the vehicle to prevent damage from leaking or spilled electrolyte during charging. See page 81.
2. Charge the battery with a charging output no larger than 1/10 of the battery's amp/hr rating. Charge as needed to raise the specific gravity to 1.270 or greater.
3. Reinstall the battery. See page 82. Make sure the positive terminal is toward the front of the vehicle.

Battery Charging (Sealed Battery)

The following battery charging instructions apply only to the installation of a sealed battery. Read all instructions before proceeding with the installation of this battery.

The sealed battery is already filled with electrolyte and has been sealed and *fully charged* at the factory. *Never* pry the sealing strip off or add any other fluid to this battery.

The single most important thing about maintaining a sealed battery is to keep it fully charged. Since the battery is sealed and the sealing strip cannot be removed, you must use a voltmeter or multimeter to measure DC voltage.

 An overheated battery may explode, causing severe injury or death. Always watch charging times carefully. Stop charging if the battery becomes very warm to the touch. Allow it to cool before resuming charging.

For a refresh charge, follow all instructions carefully.

1. Check the battery voltage with a voltmeter or multimeter. A fully charged battery will register 12.8 V or higher.
2. If the voltage is less than 12.8 volts, recharge the battery at 1.2 amps or less until battery voltage is 12.8 or greater. The battery charging harness is located under the left edge of the driver's seat. Connect the battery charging harness to the charger.



Charging Harness

Tip: When using an automatic charger, refer to the charger manufacturer's instructions for recharging. When using a constant current charger, use the guidelines on the next page for recharging.

Battery

Battery Charging (Sealed Battery)

Always verify battery condition before and 1-2 hours after the end of charging.

State of Charge	Voltage	Action	Charge Time (Using constant current charger @ standard amps specified on top of battery)
100%	12.8-13.0 volts	None, check at 3 mos. from date of manufacture	None required
75%-100%	12.5-12.8 volts	May need slight charge, if no charge given, check in 3 months	3-6 hours
50%-75%	12.0-12.5 volts	Needs charge	5-11 hours
25%-50%	11.5-12.0 volts	Needs charge	At least 13 hours, verify state of charge
0%-25%	11.5 volts or less	Needs charge with desulfating charger	At least 20 hours

MAINTENANCE

Cleaning and Storage

Washing the Vehicle

Keeping your POLARIS vehicle clean will not only improve its appearance but it can also extend the life of various components.

Before washing the vehicle, locate the CVT inlet and outlet ducts. The ducts are located under the rear wheel wells. Avoid spraying water directly toward the ducts when washing the vehicle from the rear.

NOTICE: Water in the CVT system could cause the drive belt to become wet and slip in the clutches. Always avoid spraying water directly toward the CVT inlet and outlet ducts when washing the vehicle from the rear.

High water pressure may damage components. POLARIS recommends washing the vehicle by hand or with a garden hose, using mild soap.

Certain products, including insect repellents and chemicals, will damage plastic surfaces. Do not allow these types of products to contact the vehicle.

The best and safest way to clean your POLARIS vehicle is with a garden hose and a pail of mild soap and water.

1. Use a professional-type washing cloth, cleaning the upper body first and the lower parts last.
2. Rinse with clean water frequently.
3. Dry surfaces with a chamois to prevent water spots.

Washing Tips

- Avoid the use of harsh cleaners, which can scratch the finish.
- Do not use a power washer to clean the vehicle.
- Do not use medium to heavy duty compounds on the finish.
- Always use clean cloths and pads for cleaning and polishing. Old or reused cloths and pads may contain dirt particles that will scratch the finish.

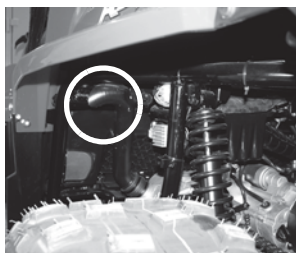

Cleaning and Storage

Washing the Vehicle

If a high pressure water system is used for cleaning (not recommended), exercise extreme caution. The water may damage components and could remove paint and labels. Avoid directing the water stream at the following items:

- Wheel bearings
- Radiator
- Transmission seals
- CVT inlet and outlet ducts
- Brakes
- Cab and body panels
- Labels and decals
- Electrical components and wiring

If an informational or graphic label becomes illegible or comes off, contact your POLARIS dealer to purchase a replacement. Replacement *safety* labels are provided by POLARIS at no charge.

Grease all zerk fittings immediately after washing. Allow the engine to run for a while to evaporate any water that may have entered the engine or exhaust system.

Polishing the Vehicle

POLARIS recommends the use of common household aerosol furniture polish for polishing the finish on your POLARIS vehicle. Follow the instructions on the container.

Polishing Tips

- Avoid the use of automotive products, some of which can scratch the finish of your vehicle.
- Always use clean cloths and pads for cleaning and polishing. Old or reused cloths and pads may contain dirt particles that will scratch the finish.

MAINTENANCE

Cleaning and Storage

Chrome Wheel Care (if equipped)

Proper maintenance will protect chrome wheels from corrosion, preserve wheel life and ensure a “like new” appearance for many years.

Tip: Chrome wheels exposed to road salt (or salt in the air in coastal areas) are more susceptible to corrosion if not properly cleaned. Clean chrome wheels more often if they're exposed to salt or other corrosive elements.

1. Wash chrome wheels frequently. Use a mild detergent. Never use abrasive cleaners on plated or painted surfaces.
2. Rinse well with clear water. Soap, detergents, salt, dirt, mud and other elements can cause corrosion.
3. Polish the clean chrome wheels periodically. Use an automotive grade chrome polish.
4. Routinely and liberally apply a weather resistant wax to each polished chrome wheel. Choose a product suitable for chrome finishes. Read and follow the product labels and instructions.

Removing Corrosion

If light rust is found on the chrome finish, use steel wool (#0000-OTT grade) to remove it. Gently rub the affected areas with the steel wool until the corrosion has been removed. Clean and polish the wheel as outlined above.

Cleaning and Storage

Storage Tips

NOTICE: Starting the engine during the storage period will disturb the protective film created by fogging and damage could occur. Never start the engine during the storage period.

Clean the Exterior

Make any necessary repairs and clean the vehicle as recommended. See page 86.

Stabilize the Fuel

1. Fill the fuel tank.
2. Add POLARIS Carbon Clean Fuel Treatment or POLARIS Fuel Stabilizer or equivalent fuel treatments or stabilizers. Follow the instructions on the container for the recommended amount. Carbon Clean removes water from fuel systems, stabilizes fuel and removes carbon deposits from pistons, rings, valves and exhaust systems.
3. Allow the engine to run for 15-20 minutes to allow the stabilizer to disperse through the entire fuel delivery system.

Air Filter / Air Box

Inspect and clean or replace the air filter. See page 67. Clean the air box. Drain the sediment tube.

Fluid Levels

Inspect the fluid levels. Add or change fluids as recommended in the Periodic Maintenance Chart beginning on page 53.

- Transmission fluid
- Brake fluid (change every two years and any time the fluid looks dark or contaminated)

Engine Oil

Change the oil. See page 60.

MAINTENANCE

Cleaning and Storage

Storage Tips

Inspect and Lubricate

Inspect all cables and lubricate all areas of the vehicle as recommended in the Periodic Maintenance Chart beginning on page 53.

Fog the Engine

1. Treat the fuel system with POLARIS Carbon Clean or other equivalent fuel treatment. Follow the instructions on the container. Start the engine. Allow it to idle for several minutes so the Carbon Clean reaches the injectors. Stop the engine.
2. Remove the spark plug and add 2-3 tablespoons of engine oil. To access the plug hole, use a section of clear 1/4" hose and a small plastic squeeze bottle filled with the pre-measured amount of oil.
3. Reinstall the spark plug. Torque to specification. See page 65.
4. Apply dielectric grease to the inside of the spark plug cap. *Do not reinstall the cap onto the plug at this step.*
5. Turn the engine over several times. Oil will be forced in and around the piston rings and ring lands, coating the cylinder with a protective film of fresh oil.
6. If fuel system additive is not used, fuel tank, fuel lines, and injectors should be completely drained of gasoline.
7. Reinstall the spark plug cap to the spark plug.

Battery Maintenance

See pages 83-85 for storage and charging procedures.

Storage Area/Covers

Be sure the storage area is well ventilated. Cover the vehicle with a genuine POLARIS cover. Do not use plastic or coated materials. They do not allow enough ventilation to prevent condensation, and may promote corrosion and oxidation.

Cleaning and Storage

Removal from Storage

1. Check the battery electrolyte level and charge the battery if necessary. Install it in the vehicle. Make sure the battery vent hose is routed properly and that it's not pinched or restricted in any way.
2. Make sure the spark plug is tight.
3. Fill the fuel tank with fuel.
4. Check all the points listed in the Daily Pre-Ride Inspection section on page 38. Tightness of the bolts, nuts and other fasteners should be checked by an authorized POLARIS dealer or other qualified service facility.
5. Lubricate at the intervals outlined in the Periodic Maintenance Chart beginning on page 53.

Transporting the Vehicle

Follow these procedures when transporting the vehicle.

1. Place the transmission in neutral. Set the parking brake.
2. Stop the engine.
3. Remove the key to prevent loss during transporting.
4. Secure the fuel cap and seats. Ensure that the seats are attached correctly and are not loose.

NOTICE: Always tie the frame of the POLARIS vehicle to the transporting unit securely with suitable straps or rope. Do not attach tie straps to the front control arm bolt pockets.

5. Wrap the front tie strap through the frame tubes, or attach a tie-down hook around each of the tubes.
6. Wrap the rear tie strap around the swing arm.

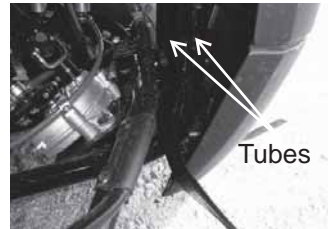

Step 5



Step 5



Step 6

SPECIFICATIONS

RZR 170	
Maximum Rider Weight	150 lbs. (68 kg) (each rider)
Maximum Weight Capacity	300 lbs. (136 kg)
Gross Vehicle Weight	840 lbs. (381 kg)
Dry Weight	500 lbs. (227 kg)
Fuel Capacity	2.5 gal. (9.5 ltr)
Engine Oil Capacity	37 oz. (1.1 ltr)
Transmission Oil Capacity	23.7 oz. (700 ml)
Overall Length	85 in. (216 cm)
Overall Width	48 in. (122 cm)
Overall Height	55 in. (139.7 cm)
Wheelbase	65 in. (165 cm)
Ground Clearance	6 in. (15.2 cm)
Engine Type	4-Stroke
Displacement	169 cc
Cooling	Air Cooled
Bore x Stroke	61 mm x 57.8 mm
Alternator Output	80 watts
Compression Ratio	9.5:1
Starting System	Electric
Fuel System	Electronic fuel injection
Throttle Body Size	36 mm
Ignition System	CDI
Ignition Timing	32° +/- 2° @ 5000 RPM
Spark Plug / Gap	NGK CR6HSA / 0.6-0.7 mm
Front Suspension	Single A-arm w/5 in. (12.7 cm) travel
Rear Suspension	Dual Shock swing arm w/5 in. (12.7 cm) travel
Lubrication System	Wet Sump
Driving System Type	Automatic Constant Variable Transmission
Final Drive	Chain
Shift Type	F/N/R

SPECIFICATIONS

RZR 170	
Tire Size - Front	19x7-8
Tire Size - Rear	20x10-9
Tire Pressure - Front	3 psi (20.7 kPa)
Tire Pressure - Rear	3 psi (20.7 kPa)
Brakes, Front/Rear	Foot Activated, 4-wheel hydraulic disc
Parking Brake	Mechanical, Rear (Lever)
Daytime Running Lights	Dual, Standard
Brake Light	Standard

Clutching Chart

To access clutches for inspection, remove the passenger seat and remove the clutch access panel. See page 26.

ALTITUDE Meters (Feet)	SHIFT WEIGHT
0-3048 (0-10,000)	6 @ 17 grams
Above 3048 (Above 10,000)	*6 @ 15 grams PN 0454619

*Optional 15-gram weight

POLARIS PRODUCTS

Part Number	Description
Engine Lubricant	
2870791	Fogging Oil (12 oz. Aerosol)
2878920	PS-4 Extreme Duty Synthetic 10W-50 4-Cycle Oil (qt./.95 l)
2878919	PS-4 Extreme Duty Synthetic 10W-50 4-Cycle Oil (gal./3.8 l)
Gearcase / Transmission Lubricants	
2878068	AGL Full Synthetic Gearcase Lubricant & Transmission Fluid (qt./.95 l)
2878069	AGL Full Synthetic Gearcase Lubricant & Transmission Fluid (gal./3.8 l)
2872348	Chain Lube, Aerosol
Grease / Specialized Lubricants	
2871312	Grease Gun Kit, All Season Grease
2871322	All Season Grease (3 oz./89 ml cartridge)
2871423	All Season Grease (14 oz./414 ml cartridge)
2871329	Dielectric Grease (Nyogel™)
Additives / Miscellaneous	
2871326	Carbon Clean
2870652	Fuel Stabilizer
2872189	DOT 4 Brake Fluid
2871956	Loctite™ 565 Thread Sealant
2859044	POLARIS Battery Tender™ Charger

TROUBLESHOOTING

Drive Belt Wear/Burn

Possible Cause	Solution
Driving at low RPM or ground speed	Drive at a higher speed.
Insufficient warm-up at low ambient temperatures	Warm the engine at least 5 minutes. With the transmission in neutral, apply small amount of throttle in short bursts, 5 to 7 times. The belt will become more flexible and prevent belt burning.
Slow/easy clutch engagement	Use the throttle quickly and effectively.
Belt slippage from water or snow ingestion into the CVT system	Dry out the CVT (see page 66). <i>Prevent water from entering the CVT inlet and outlet ducts (see page 86).</i> Inspect clutch seals for damage if repeated leaking occurs.
Clutch malfunction	Your POLARIS dealer can assist.
Poor engine performance	Check for fouled plug or foreign material in gas tank or fuel lines. Your POLARIS dealer can assist.
Wrong or missing belt	Install the recommended belt.
Improper break-in	Always break in a new belt and/or clutch. See page 36.

TROUBLESHOOTING

Engine Doesn't Turn Over

Possible Cause	Solution
Low battery voltage	Recharge the battery to 12.8 VDC
Loose battery connections	Check all connections and tighten
Loose solenoid connections	Check all connections and tighten

Engine Turns Over, Fails to Start

Possible Cause	Solution
Out of fuel	Refuel
Water is present in fuel	Drain the fuel system and refuel
Old or non-recommended fuel	Replace with fresh recommended fuel
Fouled or defective spark plug	Inspect plug and replace if necessary
No spark to spark plug	Inspect plug and replace if necessary
Water or fuel in crankcase	Your POLARIS dealer can assist.
Clogged fuel filter	Your POLARIS dealer can assist.
Low battery voltage	Recharge the battery to 12.8 VDC
Mechanical failure	Your POLARIS dealer can assist.

Engine Backfires

Possible Cause	Solution
Weak spark from spark plug	Inspect, clean and/or replace spark plug
Incorrect spark plug gap or heat range	Set gap to specs or replace plug
Old or non-recommended fuel	Replace with fresh recommended fuel
Incorrectly installed spark plug wires	Your POLARIS dealer can assist.
Incorrect ignition timing	Your POLARIS dealer can assist.
Mechanical failure	Your POLARIS dealer can assist.
Loose ignition connections	Check all connections and tighten
Water present in fuel	Replace with fresh recommended fuel
Exhaust system leak	Your POLARIS dealer can assist.

TROUBLESHOOTING

Engine Pings or Knocks

Possible Cause	Solution
Poor quality or low octane fuel	Replace with recommended fuel
Incorrect ignition timing	Your POLARIS dealer can assist.
Incorrect spark plug gap or heat range	Set gap to specs or replace plug

Engine Runs Irregularly, Stalls or Misfires

Possible Cause	Solution
Fouled or defective spark plug	Inspect, clean and/or replace spark plug
Worn or defective spark plug wires	Your POLARIS dealer can assist.
Incorrect spark plug gap or heat range	Set gap to specs or replace plug
Loose ignition connections	Check all connections and tighten
Water present in fuel	Replace with new fuel
Low battery voltage	Recharge battery to 12.8 VDC
Kinked or plugged fuel tank vent line	Inspect and replace
Incorrect fuel	Replace with recommended fuel
Clogged air filter	Inspect and clean or replace
Electronic throttle control malfunction	Your POLARIS dealer can assist.
Other mechanical failure	Your POLARIS dealer can assist.

Possible Lean Fuel Cause	Solution
Low or contaminated fuel	Add or change fuel, clean the fuel system
Low octane fuel	Replace with recommended fuel
Clogged fuel filter	Your POLARIS dealer can assist.
Incorrect fuel	Replace with recommended fuel

Possible Rich Fuel Cause	Solution
Fuel is very high octane	Replace with lower octane fuel
Stopping/starting without adequate warm-up	Allow engine to warm up before operating and/or stopping
Incorrect fuel	Replace with recommended fuel
Clogged air filter	Inspect and clean or replace

TROUBLESHOOTING

Engine Stops or Loses Power

Possible Cause	Solution
Out of fuel	Refuel
Kinked or plugged fuel vent line	Inspect and replace
Water is present in fuel	Replace with new fuel
Fouled or defective spark plug	Inspect, clean and/or replace spark plug
Worn or defective spark plug wires	Your POLARIS dealer can assist.
Incorrect spark plug gap or heat range	Set gap to specs or replace plug
Loose ignition connections	Check all connections and tighten
Low battery voltage	Recharge the battery to 12.8 VDC
Incorrect fuel	Replace with fresh recommended fuel
Clogged air filter	Inspect and clean or replace
Electronic throttle control malfunction	Your POLARIS dealer can assist.
Other mechanical failure	Your POLARIS dealer can assist.

WARRANTY

LIMITED WARRANTY

POLARIS Industries Inc., 2100 Highway 55, Medina, MN 55340 (POLARIS) gives a SIX MONTH LIMITED WARRANTY on all components of your POLARIS vehicle against defects in material or workmanship. POLARIS further warrants that the spark arrester in this product will meet the efficiency requirements of USFS standard 5100-1C for at least 1000 hours when subjected to normal use and when maintenance and installation are in accordance with POLARIS recommendations.

This warranty covers parts and labor charges for repair or replacement of defective parts and begins on the date of purchase by the original retail purchaser. This warranty is transferable to another owner during the warranty period through a POLARIS dealer, but any such transfer will not extend the original term of the warranty. The duration of this warranty may vary by international region based upon local laws and regulations.

Registration

At the time of sale, the Warranty Registration Form must be completed by your dealer and submitted to POLARIS within ten days of purchase. Upon receipt of this registration, POLARIS will record the registration for warranty. No verification of registration will be sent to the purchaser as the copy of the Warranty Registration Form will be your proof of warranty coverage. If you have not signed the original registration and received the customer copy, please contact your dealer immediately. **NO WARRANTY COVERAGE WILL BE ALLOWED UNLESS YOUR VEHICLE IS REGISTERED WITH POLARIS.** Initial dealer preparation and set-up of your vehicle is very important in ensuring trouble-free operation. Purchasing a machine in the crate or without proper dealer set-up will void your warranty coverage.

Warranty Coverage And Exclusions:

Limitations Of Warranties And Remedies

This POLARIS limited warranty excludes any failures that are not caused by a defect in material or workmanship. **THIS WARRANTY DOES NOT COVER CLAIMS OF DEFECTIVE DESIGN.** This warranty also does not cover acts of God, accidental damage, normal wear and tear, abuse or improper handling. This warranty also does not cover any vehicle, component, or part that has been altered structurally, modified, neglected, improperly maintained or used for racing, competition or purposes other than for which it was designed.

This warranty excludes damages or failures resulting from improper lubrication; improper engine timing; improper fuel; surface imperfections caused by external stress, heat, cold or contamination; operator error or abuse; improper component alignment, tension, adjustment or altitude compensation; snow, water, dirt or other foreign substance ingestion/contamination; improper maintenance; modified components; use of aftermarket or unapproved components, accessories, or attachments; unauthorized repairs; or repairs made after the warranty period expires or by an unauthorized repair center.

WARRANTY

Warranty Coverage And Exclusions: Limitations Of Warranties And Remedies

This warranty excludes damages or failures caused by abuse, accident, fire, or any other cause other than a defect in materials or workmanship and provides no coverage for consumable components, general wear items, or any parts exposed to friction surfaces, stresses, environmental conditions and/or contamination for which they were not designed or not intended, including but not limited to the following items:

- Wheels and tires
- Suspension components
- Brake components
- Seat components
- Clutches and components
- Steering components
- Batteries
- Light bulbs/Sealed beam lamps
- Filters
- Lubricants
- Bushings
- Finished and unfinished surfaces
- Carburetor/Throttle body components
- Engine components
- Drive belts
- Hydraulic components and fluids
- Circuit breakers/Fuses
- Electronic components
- Spark plugs
- Sealants
- Coolants
- Bearings

Lubricants and Fluids

1. Mixing oil brands or using non-recommended oil may cause engine damage. We recommend the use of POLARIS engine oil.
2. Damage or failure resulting from the use of non-recommended lubricants or fluids is not covered by this warranty.

This warranty provides no coverage for personal loss or expense, including mileage, transportation costs, hotels, meals, shipping or handling fees, product pick-up or delivery, replacement rentals, loss of product use, loss of profits, or loss of vacation or personal time.

THE EXCLUSIVE REMEDY FOR BREACH OF THIS WARRANTY SHALL BE, AT POLARIS' OPTION, REPAIR OR REPLACEMENT OF ANY DEFECTIVE MATERIALS, COMPONENTS, OR PRODUCTS. THE REMEDIES SET FORTH IN THIS WARRANTY ARE THE ONLY REMEDIES AVAILABLE TO ANY PERSON FOR BREACH OF THIS WARRANTY. POLARIS SHALL HAVE NO LIABILITY TO ANY PERSON FOR INCIDENTAL, CONSEQUENTIAL OR SPECIAL DAMAGES OF ANY DESCRIPTION, WHETHER ARISING OUT OF EXPRESS OR IMPLIED WARRANTY OR ANY OTHER CONTRACT, NEGLIGENCE, OR OTHER TORT OR OTHERWISE. THIS EXCLUSION OF CONSEQUENTIAL, INCIDENTAL, AND SPECIAL DAMAGES IS INDEPENDENT FROM AND SHALL SURVIVE ANY FINDING THAT THE EXCLUSIVE REMEDY FAILED OF ITS ESSENTIAL PURPOSE.

THE IMPLIED WARRANTY OF FITNESS FOR A PARTICULAR PURPOSE IS EXCLUDED FROM THIS LIMITED WARRANTY. ALL OTHER IMPLIED WARRANTIES (INCLUDING BUT NOT LIMITED TO THE IMPLIED WARRANTY OF MERCHANTABILITY) ARE LIMITED IN DURATION TO THE ABOVE SIX MONTH WARRANTY PERIOD. POLARIS DISCLAIMS ALL EXPRESS WARRANTIES NOT STATED IN THIS WARRANTY. SOME STATES DO NOT PERMIT THE EXCLUSION OR LIMITATION OF INCIDENTAL OR CONSEQUENTIAL DAMAGES OR ALLOW LIMITATIONS ON THE DURATION OF IMPLIED WARRANTIES, SO THE ABOVE LIMITATIONS MAY NOT APPLY TO YOU IF INCONSISTENT WITH CONTROLLING STATE LAW.

WARRANTY

How To Obtain Warranty Service

If your vehicle requires warranty service, you must take it to a POLARIS Servicing Dealer. When requesting warranty service you must present your copy of the Warranty Registration Form to the dealer. (THE COST OF TRANSPORTATION TO AND FROM THE DEALER IS YOUR RESPONSIBILITY.) POLARIS suggests that you use your original selling dealer; however, you may use any POLARIS Servicing Dealer to perform warranty service.

In the Country where your product was purchased:

Warranty or Service Bulletin repairs must be done by an authorized POLARIS dealer. If you move or are traveling within the country where your product was purchased, Warranty and Service Bulletin repairs may be requested from any authorized POLARIS dealer that sells the same line as your product.

Outside the Country where your product was purchased:

If you are traveling temporarily outside the country where your product was purchased, you should take your product to an authorized POLARIS dealer. You must show the dealer photo identification from the country of the selling dealer's authorized location as proof of residence. Upon residence verification, the servicing dealer will be authorized to perform the warranty repair.

If you move:

If you move to another country, be sure to contact POLARIS Customer Assistance and the customs department of the destination country before you move. Product importation rules vary considerably from country to country. You may be required to present documentation of your move to POLARIS in order to continue your warranty coverage. You may also be required to obtain documentation from POLARIS in order to register your product in your new country. You should warranty register your product at a local POLARIS dealer in your new country immediately after you move to continue your warranty coverage and to ensure that you receive information and notices regarding your vehicle.

If you purchase from a private party:

If you purchase a POLARIS product from a private party, to be kept and used outside of the country in which the product was originally purchased, all warranty coverage will be denied. You must nonetheless register your product under your name and address with a local POLARIS dealer in your country to ensure that you receive safety information and notices regarding your product.

Exported Products

EXCEPT WHERE SPECIFICALLY REQUIRED BY LAW, THERE IS NO WARRANTY OR SERVICE BULLETIN COVERAGE ON THIS PRODUCT IF IT IS SOLD OUTSIDE THE COUNTRY OF THE SELLING DEALER'S AUTHORIZED LOCATION. This policy does not apply to products that have received authorization for export from POLARIS. Dealers may not give authorization for export. You should consult an authorized dealer to determine this product's warranty or service coverage if you have any questions. This policy does not apply to products registered to government officials or military personnel on assignment outside the country of the selling dealer's authorized location. This policy does not apply to Safety Bulletins.

WARRANTY

Notice

If your product is registered outside of the country where it was purchased and you have not followed the procedure set above, your product will no longer be eligible for warranty or service bulletin coverage of any kind, other than safety bulletins. Products registered to government officials or military personnel on assignment outside of the country where the product was purchased will continue to be covered by the Limited Warranty.

Please work with your dealer to resolve any warranty issues. Should your dealer require any additional assistance, they will contact the appropriate person at POLARIS.

This warranty gives you specific legal rights, and you may also have other rights which vary from state to state or in different countries. If any of the above terms are void because of federal, state, local law, all other warranty terms will remain in effect.

For questions call POLARIS Customer Assistance:

United States & Canada: 1-800-POLARIS (1-800-765-2747)

French: 1-800-268-6334

U.S.A. EPA Emissions Limited Warranty

This emissions limited warranty is in addition to the POLARIS standard limited warranty for your vehicle. POLARIS Industries Inc. warrants that at the time it is first purchased, this emissions-certified vehicle is designed, built and equipped so it conforms with applicable U.S. Environmental Protection Agency emission regulations. POLARIS warrants that the vehicle is free from defects in materials and workmanship that would cause it to fail to meet these regulations.

The warranty period for off road vehicles 100cc or greater emissions-certified vehicles starts on the date of purchase by original retail purchaser and continues for a period of 500 hours of engine operation, 5000 kilometers (3100 miles) of vehicle travel, or 30 calendar months from the date of purchase, whichever comes first. The warranty period for ATVs less than 100cc emissions-certified vehicles starts on the date of purchase by original retail purchaser and continues for a period of 250 hours of engine operation, 2500 kilometers (1550 miles) of vehicle travel, or 30 calendar months from the date of purchase, whichever comes first. This EPA emissions warranty period is extended for at least as long as the standard factory warranty that Polaris provides on the vehicle as a whole. The EPA emissions warranty period does not further extend if you purchase additional warranty coverage in the form of a service contract or other paid warranty extension, but emission-related parts may be covered subject to the terms of any such paid service contract or paid warranty extension.

This emissions limited warranty covers components whose failure increases the vehicle's regulated emissions, and it covers components of systems whose only purpose is to control emissions. Repairing or replacing other components not covered by this warranty is the responsibility of the vehicle owner. This emissions limited warranty does not cover components whose failure does not increase the vehicle's regulated emissions.

For exhaust emissions, emission-related components include any engine parts related to the following systems:

- Air-induction system
- Fuel system
- Ignition system
- Exhaust gas recirculation systems

The following parts are also considered emission-related components for exhaust emissions:

- Aftertreatment devices
- Crankcase ventilation valves
- Sensors
- Electronic control units

WARRANTY

U.S.A. EPA Emissions Limited Warranty

The following parts are considered emission-related components for evaporative emissions:

- Fuel Tank
- Fuel Cap
- Fuel Line
- Fuel Line Fittings
- Clamps*
- Pressure Relief Valves*
- Control Valves*
- Control Solenoids*
- Electronic Controls*
- Vacuum Control Diaphragms*
- Control Cables*
- Control Linkages*
- Purge Valves
- Vapor Hoses
- Liquid/Vapor Separator
- Carbon Canister
- Canister Mounting Brackets
- Carburetor Purge Port Connector

*As related to the evaporative emission control system.

Emission-related components also include any other part whose only purpose is to reduce emissions or whose failure will increase emissions without significantly degrading engine/equipment performance. The exclusive remedy for breach of this limited warranty shall be, at the exclusive option of POLARIS, repair or replacement of any defective materials, components or products. **THE REMEDIES SET FORTH IN THIS LIMITED WARRANTY ARE THE ONLY REMEDIES AVAILABLE TO ANY PERSON FOR BREACH OF THIS WARRANTY. POLARIS SHALL HAVE NO LIABILITY TO ANY PERSON FOR INCIDENTAL, CONSEQUENTIAL OR SPECIAL DAMAGES OF ANY DESCRIPTION, WHETHER ARISING OUT OF EXPRESS OR IMPLIED WARRANTY OR ANY OTHER CONTRACT, NEGLIGENCE OR OTHER TORT OR OTHERWISE. THIS EXCLUSION OF CONSEQUENTIAL, INCIDENTAL, AND SPECIAL DAMAGES IS INDEPENDENT FROM AND SHALL SURVIVE ANY FINDING THAT THE EXCLUSIVE REMEDY FAILED OF ITS ESSENTIAL PURPOSE.**

ALL IMPLIED WARRANTIES (INCLUDING BUT NOT LIMITED TO ANY IMPLIED WARRANTIES OF MERCHANTABILITY AND FITNESS FOR A PARTICULAR PURPOSE) ARE LIMITED IN DURATION TO THE WARRANTY PERIOD DESCRIBED HEREIN. POLARIS DISCLAIMS ALL EXPRESS WARRANTIES NOT STATED IN THIS WARRANTY. Some states do not allow limitations on how long an implied warranty lasts, so the above limitation may not apply if it is inconsistent with the controlling state law.

This limited warranty excludes failures not caused by a defect in material or workmanship. This limited warranty does not cover damage due to accidents, abuse or improper handling, maintenance or use. This limited warranty also does not cover any engine that has been structurally altered, or when the vehicle has been used in racing competition. This limited warranty also does not cover physical damage, corrosion or defects caused by fire, explosions or other similar causes beyond the control of POLARIS.

WARRANTY

U.S.A. EPA Emissions Limited Warranty

Owners are responsible for performing the scheduled maintenance identified in the owner's manual. POLARIS may deny warranty claims for failures that have been caused by the owner's or operator's improper maintenance or use, by accidents for which POLARIS has no responsibility, or by acts of God.

Any qualified repair shop or person may maintain, replace, or repair the emission control devices or systems on your vehicle. An authorized POLARIS dealer can perform any service that may be necessary for your vehicle. POLARIS also recommends POLARIS parts, however equivalent parts may be used for such service. It is a potential violation of the Clean Air Act if a part supplied by an aftermarket parts manufacturer reduces the effectiveness of the vehicle's emission controls. Tampering with emission controls is prohibited by federal law.

California Residents

Certain POLARIS Off-Road Vehicles are available in 49-state and 50-state versions. Only the 50-state models are certified for sale in California. The 50-state models available for sale in California are identified by the letter "B" in the ninth position of the model number (e.g., R16RTE87B). The POLARIS 50-state models are designed and built with features such as a reduced cargo box capacity. Any modifications to these features may be a violation of the applicable California regulations and may void this limited emissions warranty offered by the manufacturer.

If you have any questions regarding your warranty rights and responsibilities, please contact POLARIS Customer Assistance:

United States & Canada: 1-800-POLARIS (1-800-765-2747)

French: 1-800-268-6334

INDEX

A

Adjustment, Steering Wheel	27
Adjustment, Throttle Freeplay	70
Air Filter	67
Air Filter Cleaning	67
Arrester, Spark, Warning	68

B

Battery	80-85
Battery Charging	84-85
Battery Fluid Replenishment	83
Battery Installation	82
Battery Removal	81
Battery Storage	83
Before Riding	38
Belt Burning	95
Belt Wear	95
Belts, Seat	28-29
Boots	11
Brake Adjustment, Parking	64
Brake Adjustment	64
Brake Fluid	73
Brake Inspection	72
Brake Pedal	34
Brake System Break-in	37
Brakes	71-73
Braking	41
Break-In Period	36-37
Burning Belts	95

C

Cab Nets	30
Changing Gears	33
Chart, Periodic Maintenance	53-57
Chrome Wheel Care	88
Cleaning and Storage	86-91
Cleaning the Air Filter	67
Cleaning, Exhaust System	68
Cleaning, Spark Arrester	68
Clothing	11
Clutching Chart	93
Component Locations	24-25
Condition, Spark Plugs	65
Constant Variable Transmission	66
Corrosion Removal, Chrome	88
Cover for Storage	90
Crankcase Emission Control System	52
CVT Break-In	37
CVT Drying	66
CVT System	66

D

Drive Belt Wear	95
Drive Chain Lubrication	62
Drive Chain Slack	62
Drive Chain Slack Adjustment	63
Drivetrain Break-In	37
Driving Downhill	47
Driving in Reverse	50
Driving on a Sidehill	47
Driving on Slippery Surfaces	45
Driving Over Obstacles	49
Driving Procedures	42-43
Driving Through Water	48
Driving Uphill	46
Driving with a Passenger	44

E

Electromagnetic Interference	52
Emission Control, Crankcase	52
Emission Control, Exhaust	52
Emission Control, Noise	52
Emissions Limited Warranty	103-105
Engine Break-In	37
Engine Fogging	90
Engine Oil	59-60
Engine Stopping	41
Equipment Modifications	9
Exhaust Cleaning	68
Exhaust Emission Control System	52
Exhaust System Warning	68
Eye Protection	11

F

Filling the Battery	83
Filter Care During Storage	89
Filter Cleaning, Air	67
Filter Systems	67
Filter, Air	67
Fluid	
Main Gearcase	61
Transmission	61
Fluid Change	
Main Gearcase	61
Transmission	61
Fluid Check	
Main Gearcase	61
Transmission	61
Fluid Levels During Storage	89
Fluid, Battery	83
Fluid, Brake	73

INDEX

F

Fogging the Engine	90
Fouled Plugs	65
Freeplay Adjustment, Throttle	70
Freeplay, Steering Wheel	74
Fuel Cap	31
Fuel Safety	21
Fuel Stabilizer	89
Fuel Tank Filler Cap	31

G

Gap, Spark Plug	65
Gasoline Handling	21
Gear Selector	33
Gearcase Oil, Main	61
Gearcases	
Main Gearcase	61
Transmission	61
Gears, shifting	33
Gloves	11

H

Hand Hold, Passenger	27
Helmet	10

I

Ignition Switch	32
Inspection, Brakes	72
Inspection, Pre-Ride	38
Inspection, Seat Belts	29
Inspection, Steering Wheel	74
Inspection, Throttle Freeplay	69
Installation, Battery	82
Installation, Wheels	77
Interference, Electromagnetic	52

K

Key, Periodic Maintenance Chart	54
---------------------------------	----

L

Lamp Replacement	
Taillight	78
Daytime Running Lights	78
Lights	78
Lubricant Part Numbers	94
Lubrication for Storage	90
Lubrication Recommendations	58

M

Maintenance Log	106-107
Maintenance, Periodic	53-57

N

Nets, Cab	30
New Operator Procedures	42-43
Noise Emission Control System	52

O

Obstacles	49
Oil	
Engine	59-60
Main Gearcase	61
Transmission	61
Oil Change	
Engine Oil	60
Main Gearcase	61
Transmission	61
Oil Check	
Engine Oil	59
Main Gearcase	61
Transmission	61
Operation on Public Lands	52

P

Parking Brake Adjustment	64
Parking Brake Cable Freeplay	64
Parking on an Incline	51
Parking the Vehicle	41
Passenger Hand Hold Adjustment	27
Periodic Maintenance Chart	53-57
Plug Condition	65
Plug Gap	65
Plug Torque	65
Plug, Spark	65
Plugs, Fouled	65
Polaris Products	94
Polishing the Vehicle	87
Pre-Ride Inspection	38
Public Lands	52

R

Refueling Safety	21
Registration, Warranty	99
Removal, Battery	81
Removal, Seat	26
Removal, Wheels	76
Removing the Vehicle from Storage	91
Reverse	50
Riding Gear	10-11

INDEX

S

Safe Operation Practices	39
Safety Labels	22-23
Safety Symbols	6
Safety Warnings	12-21
Seat Adjustment, Driver's	26
Seat Belt Cleaning	29
Seat Belt Inspection	29
Seat Belts	28-29
Seat Removal	26
Selector, Gear	33
Severe Use Definition	53
Shifting Gears	33
Shock Spring Adjustment	74
Signal Words	6
Spark Arrester Cleaning	68
Spark Arrester Warning	68
Spark Plug	65
Spark Plug Condition	65
Spark Plug Gap	65
Spark Plug Removal	65
Spark Plug Torque	65
Spark Plugs, Fouled	65
Specifications	92-93
Speed Control System	35
Stabilizing the Fuel	89
Steering Wheel Adjustment	27
Steering Wheel Inspection	74
Stopping the Engine	41
Storage	86-91
Storage and Inspection	90
Storage and Lubrication	90
Storage Area	90
Storage, Battery	83
Storage, Covers	90
Storage, Fluid Levels	89
Storage, Oil Change	89
Storage, Removal	91

T

Taillight	78
Throttle Freeplay Adjustment	70
Throttle Freeplay Inspection	69
Throttle Freeplay, Freeplay, Throttle	69
Throttle Pedal	34
Throttle System	69
Tire Tread Depth	76
Tires	76-77
Front Wheel Hub Tightening	76
Wheel Nut Torque	77
Toe Alignment	75
Torque, Spark Plug	65
Transmission Oil	61
Transporting the Vehicle	91
Tread Depth, Tire	76

V

Vehicle Identification Numbers	8
Vehicle Immersion	79
Vehicle Transport	91

W

Warning Symbols	6
Washing the Vehicle	86-87
Water, Immersion of Vehicle	79
Wear, Drive Belt	95
Wheel Hub Tightening	76
Wheel Installation	77
Wheel Nut Torque Specifications	77
Wheel Removal	76

WARNING

Improper vehicle use can result in SEVERE INJURY or DEATH

NEVER allow vehicle to be operated:

- without all occupants first viewing and understanding safety video and warning labels.
- with more than one passenger.
- on hills steeper than 15 degrees $\leq 15^\circ$.
- on paved surfaces - pavement may seriously affect handling and control.
- with non-Polaris approved accessories - they may seriously affect stability.
- at speeds that are too fast for the operator's skills, the conditions and/or the terrain.

ALWAYS require operator and passenger to:

- wear seat belts, grab hand holds (passenger) and plant feet firmly on the floor.
- secure cab nets.
- keep hands and feet inside vehicle.
- avoid quick turns of the steering wheel and driving stunts such as jumps, donuts or power slides.
- reduce speed and use extra caution when carrying a passenger.
- watch for branches or other hazards that could enter vehicle.



Operation of this vehicle by children under age 10 increases the risk of severe injury or death. Adult supervision required for children under age 16. NEVER permit children under age 10 to operate or ride in this vehicle.

ALWAYS USE AN APPROVED HELMET AND PROTECTIVE GEAR FOR ALL OCCUPANTS.

READ OWNER'S MANUAL. FOLLOW ALL INSTRUCTIONS AND WARNINGS.



POLARIS®

For your nearest Polaris dealer,
call 1-800-POLARIS (765-2747)
or visit www.polaris.com

Polaris Industries Inc.
2100 Highway 55
Medina, MN 55340

Part No. 9927394 Rev 01
Printed in Taiwan

